

Industrial processes range guide



Contents

VULCATHENE ● 4

System for chemical drainage

Pipe, bench products & ancillaries	6-8
Mechanical fittings	9-11
Polyfusion/mechanical adapters	11
Enfusion fittings	12-14

SUPERFLO ABS ● 16

System for chilled & cold water

Metric pipe & solvent weld fittings	18-22
Metric accessories	22
Metric valves & accessories	23-24
Imperial pipe & solvent weld fittings	25-30
Imperial accessories	31
Imperial valves & accessories	32-34

DURAPIPE PVC ● 36

Pipework for industrial applications

Imperial system	38-46
Valves – Imperial	47-52
Metric system	53-60
Valves metric	61-64
Accessories	65

DURAPIPE POLYPROPYLENE ● 66

For the industrial processing industry

Socket Fusion – pipe & fittings	68-70
Butt Fusion – fittings	70-73
Valves - metric	74-76
Accessories	77

PLX ● 78

Specialist pipework for safe fuel transfer

PLX single wall	80-81
PLX secondary contained	82-84
PLX blue (Ad blue system)	85
PLX+ (conductive system)	86-88
PLX Tooling	90
PLX electrical conduit	91

AIR-LINE XTRA ● 92

For compressed air distribution

Pipe and fittings	94-96
Valves	96-97

DURAPIPE CORZAN CPVC ● 98

For hot and corrosive chemicals

Pipe and fittings	100-102
Valves and accessories	103-105

DURAPIPE GUARDIAN ● 106

Specialist dual contained pipework

Pipe and fittings	108-109
-------------------	---------

GPS PE BLACK ● 110

Pipe for raw water and sewage

Pipe and coils	112-113
----------------	---------

FRIALEN ELECTROFUSION FITTINGS ● 114

Large diameter electrofusion fittings

For all applications	116-119
For potable water applications	120
Accessories	121

ACTUATED VALVES ● 122

Flow control

Operation: electric	124-126
Operation: pneumatic	127-129
Flow control instrumentation	130



Contact us

Get in touch!

Visit: alixis.co.uk/get-in-touch

Or call: +44 (0) 330 111 4233

Vulcathene

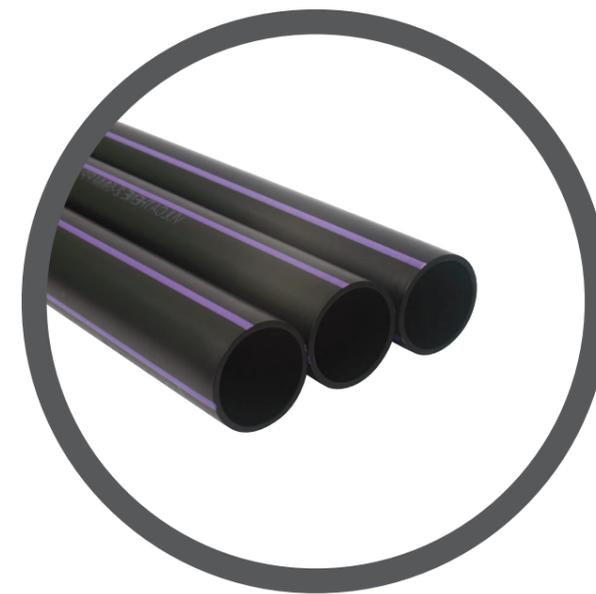

Vulcathene

Pipe, bench products and ancillaries



PIPE

Pipe Diameter (mm)	Standard Length (m)	Catalogue number	Product Code
38	4	W001	V41 0310
51	4	W001	V41 0320
76	4	W001	V41 0330
102	4	W001	V41 0340
152	4	W001	V41 0360



WASTES

Size (inch x mm x mm)	Pack qty	Catalogue number	Product Code
UNSLOTTED			
1 1/4 x 60 dia. x 89	10	504	V5 504 011
1 1/4 x 73 dia. x 102	10	504	V5 504 031
1 1/4 x 85 dia. x 102	10	504	V5 504 051
1 1/2 x 60 dia. x 89	10	504	V5 504 071
1 1/2 x 73 dia. x 102	10	504	V5 504 091
1 1/2 x 85 dia. x 102	10	504	V5 504 111
2 x 85 dia. x 102	10	504	V5 504 131
SLOTTED			
1 1/4 x 60 dia. x 89	10	504	V5 504 021
1 1/4 x 73 dia. x 102	10	504	V5 504 041
1 1/4 x 85 dia. x 102	10	504	V5 504 061
1 1/2 x 60 dia. x 89	10	504	V5 504 081
1 1/2 x 73 dia. x 102	10	504	V5 504 101
1 1/2 x 85 dia. x 102	10	504	V5 504 121
2 x 85 dia. x 102	10	504	V5 504 141



STANDING WASTE TUBES

Size (mm)	Pack quantity	Catalogue number	Product Code
32 x 140*	25	507	V5 507 011
32 x 178*	25	507	V5 507 031
38 x 140	25	507	V5 507 051
38 x 178	25	507	V5 507 071
51 x 225*	10	507	V5 507 091

FITTED WITH HANGING LOOP			
32 x 140*	25	507	V5 507 021
32 x 178*	25	507	V5 507 041
38 x 140	25	507	V5 507 061
38 x 178	25	507	V5 507 081
51 x 225*	10	507	V5 507 101

* Made to Order (Please refer to our Terms & Conditions).

WASTE GASKETS – For use with 601, 602 and 604 Series sinks and 605 Series troughs

Size (inch)	Pack quantity	Product Code
1 1/2	1	V4 000 01
2	1	V4 000 02



PLUG AND CHAIN ASSEMBLY

Size (mm)	Pack quantity	Catalogue number	Product Code
32	1	508	V5 508 501
38	1	508	V5 508 101
51	1	508	V5 508 201



OVERFLOW ASSEMBLY

Size (inch)	Pack quantity	Catalogue number	Product Code
9-22	1	509	V5 509 001

Note: The 504 waste is not included in the assembly and should be ordered separately. Size refers to length of tube.



SMALL CIRCULAR DRIP CUP

Size (mm)	Pack quantity	Catalogue number	Product Code
102 dia.	1	501	V5 501 001



LARGE CIRCULAR DRIP CUP

Size (mm)	Pack quantity	Catalogue number	Product Code
168 dia.	1	500	V5 500 001



SMALL OVAL DRIP CUP

Size (mm)	Pack quantity	Catalogue number	Product Code
175 x 102	1	497	V5 497 001



LARGE OVAL DRIP CUP

Size (mm)	Pack quantity	Catalogue number	Product Code
264 x 111	1	499B	V5 499 001



LARGE OVAL DRIP CUP

Size (mm)	Pack quantity	Catalogue number	Product Code
305 x 152	1	499T	V5 499 001

Please note: Catalogue numbers are for additional reference only, please use product code to order.

Vulcathene

Pipe, bench products and ancillaries



SINKS

Size (mm)	Pack qty	Catalogue number	Product Code
492 x 241 x 171	1	601	V4 601 00



SINKS

Size (mm)	Pack qty	Catalogue number	Product Code
552 x 400 x 231	1	602	V4 602 00



RUNNING TROUGH – Fabricated (polypropylene)

Size (mm)	Pack quantity	Catalogue number	Product Code
*	n/a	603	-

* Made to Order (Please refer to our Terms & Conditions).



ADJUSTABLE DILUTION RECOVERY TRAP – Anti-siphon, 2.3 litres capacity

Size (mm)	Pack quantity	Catalogue number	Product Code
38	1	W681	V1 068 101



ADJUSTABLE DILUTION RECOVERY TRAP – Anti-siphon, with visual glass base, 2.3 litres capacity

Size (mm)	Pack quantity	Catalogue number	Product Code
38	1	W691	V10 691 01



DILUTION RECOVERY TRAP – 4.5 litres capacity

Pack quantity	Catalogue number	Product Code
1	W612	V10 612 01



DILUTION RECOVERY TRAP/ DEMOUNTABLE LID* – With visual glass base, 4.5 litres capacity

Pack quantity	Catalogue number	Product Code
1	W910G	V10 910 001

*Inlets, glass dip tubes, blanking off plugs to be ordered separately. Note: The Vulcathene 910G Dilution Recovery Trap has been re-designed and now incorporates a removable lid for easier access and maintenance.



ADJUSTABLE ANTI-SIPHON BOTTLE TRAP

Size (mm)	Pack quantity	Catalogue number	Product Code
38	1	W561	V10 561 01



ADJUSTABLE ANTI-SIPHON BOTTLE TRAP – with visual glass base

Size (mm)	Pack quantity	Catalogue number	Product Code
38	1	W571	V10 571 01



ANTI-SIPHON UNIT

Size (mm)	Pack quantity	Catalogue number	Product Code
51	1	W50	V467020



CLAY TRAP

Pack quantity	Catalogue number	Product Code
1	W915	V10 915 01



FLOOR GULLY* – 4.5 litre trapped floor gully, 76mm plain ended outlet, 76mm trap seal

Size (litre)	Pack quantity	Product Code
4.5*	1	V18 101 00

*Floor gullies are fabricated to order; gullies with additional inlets can also be supplied. ** Made to Order (Please refer to our Terms & Conditions).



PIPE CLIPS

Size (mm)	Pack quantity	Catalogue number	Product Code
38	10	PC91	V5 091 101
51	10	PC91	V5 091 201
76	10	PC91	V5 091 301
102	2	PC91	V5 091 401

Vulcathene

Pipe, bench products and ancillaries



CLAMP SADDLES

Size (mm x BSP)	Pack quantity	Catalogue number	Product Code
102 x 2"	1	W465	V465050
102 x 1½"	1	W465	V465060
76 x 2"	1	W465	V465070
76 x 1½"	1	W465	V465080



AIR ADMITTANCE VALVE

Size (mm)	Pack quantity	Catalogue number	Product Code
102	1	W450	V466040



UNICOLLAR FIRE PROTECTION

Size (mm)	Pack quantity	Product Code
2250 strip length	1	V466100



FLEXIBLE CONNECTORS – 38mm

Size (m)	Pack quantity	Catalogue number	Product Code
1	1	W916	V5 916 001
1.5	1	W916	V5 916 015
2	1	W916	V5 916 002
3	1	W916	V5 916 003



GALVANISED SUPPORT CHANNELS – Supplied in standard lengths of 2.5m

Size (mm)	Pack quantity	Product Code
38	1	V4 650 10
51	1	V4 650 20
76	1	V4 650 30
102	1	V4 650 40



VERTICAL INLETS – for 910G

Size (mm)	Pack quantity	Catalogue number	Product Code
38	1	W651	V10 651 01
51	1	W652	V10 652 01



HORIZONTAL INLETS – for 910G

Size (mm)	Pack quantity	Catalogue number	Product Code
38	1	W641	V10 641 01
51	1	W642	V10 642 01



GLASS DIP TUBES – for 910G

Pack quantity	Product Code
1	V5 913 001



BLANKING OFF PLUGS – for 910G

Pack quantity	Product Code
1	V5 912 001



VULCATHENE LUBRICANT

Size (g)	Pack quantity	Product Code
200	12	V5 900 002



ADDITIONAL DIP TUBE – for W612

Pack quantity	Product Code
1*	V10 912 01

* Made to Order (Please refer to our Terms & Conditions).



FLEXIBLE DRAIN COUPLINGS

Size (mm)	Pack qty	Cat. number	Product Code
DC95 80-95	1	DC95	V10 0DC95
DC115 100-115	1	DC115	V10 DC115



FLEXIBLE ADAPTOR COUPLINGS

Size (mm)	Pack qty	Cat. no.	Product Code
AC1221 110-122/80-95	1	AC1221	V1 AC1221
AC1361 121-136/80-95	1	AC1361	V1 AC1361
AC5144 110-125/100-115	1	AC5144	V1 AC5144
AC1362 121-136/100-115	1	AC1362	V1 AC1362

Vulcathene

Mechanical fittings



92½° SWEEP BENDS

Size (mm)	Pack quantity	Catalogue number	Product Code
38	10	W181	V10 181 01
51	5	W182	V10 182 01
76	1	W183	V10 183 01
102	1	W184	V10 184 01



92½° LOOSE NUT SWEEP BENDS

Size (mm)	Pack quantity	Catalogue number	Product Code
38	10	W291	V10 291 01
51	10	W292	V10 292 01
76	1	W293	V10 293 01
102	1	W294	V10 294 01



135° SLOW BENDS

Size (mm)	Pack quantity	Catalogue number	Product Code
38	10	W191	V10 191 01
51	5	W192	V10 192 01
76	1	W193	V10 193 01
102	1	W194	V10 194 01



135° LOOSE NUT SLOW BENDS

Size (mm)	Pack quantity	Catalogue number	Product Code
38	10	W211	V10 211 01
51	5	W212	V10 212 01
76	1	W213	V10 213 01
102	1	W214	V10 214 01



92½° EQUAL SWEEP TEES*

Size (mm)	Pack quantity	Catalogue number	Product Code
38	5	W201	V10 201 01
51	5	W202	V10 202 01
76	1	W203	V10 203 01
102	1	W204	V10 204 01

*Note: Apart from the 51mm x 38mm fitting which is produced as a one piece moulding, all other reducing sweep tees are made up with a W20 'Series' equal sweep tee with the addition of a W39 'Series' reducing coupler which should be ordered as a separate item.



92½° REDUCING SWEEP TEE

Size (mm)	Pack quantity	Catalogue number	Product Code
51 x 38	5	W2021	V10 202 11



45° SINGLE WYES

Size (mm)	Pack quantity	Catalogue number	Product Code
38	10	W371	V10 371 01
51	5	W372	V10 372 01
76	1	W373	V10 373 01
102	1	W374	V10 374 01



45° DOUBLE WYES

Size (mm)	Pack quantity	Catalogue number	Product Code
38	5	W381	V10 381 01
51	1	W382	V10 382 01
76	1	W383	V10 383 01
102	1	W384	V10 384 01



90° CORNER BRANCH*

Size (mm)	Pack quantity	Catalogue number	Product Code
102 x 51	1	W942	V10 942 01

*Fabricated.



TUBULAR TRAP – U-BENDS

Size (mm)	Pack quantity	Catalogue number	Product Code
38	5	W701	V10 701 01
51	1	W702	V10 702 01

Tubular traps should be assembled from stock components using a W70 'Series' 'U' bend and additional items as indicated in technical catalogue such as P traps, S traps and running traps



LINE COUPLERS

Size (mm)	Pack quantity	Catalogue number	Product Code
38	10	W161	V10 161 01
51	10	W162	V10 162 01
76	1	W163	V10 163 01
102	1	W164	V10 164 01



REDUCING COUPLERS

Size (mm)	Pack quantity	Catalogue number	Product Code
51 x 38	10	W3921	V10 39 211
76 x 38	10	W3931	V10 39 311
76 x 51	10	W3932	V10 39 321
102 x 38	1	W3941	V10 39 411
102 x 51	1	W3942	V10 39 421
102 x 76	1	W3943	V10 39 431

Vulcathene

Mechanical fittings



M.I. TO PIPE COUPLERS

Size (mm)	Pack quantity	Catalogue number	Product Code
38	10	W141	V10 141 01
51	10	W142	V10 142 01



F.I. TO PIPE COUPLERS

Size (mm)	Pack quantity	Catalogue number	Product Code
38	10	W151	V10 151 01
51	10	W152	V10 152 01



1/4" F.I. X 1/2" M.I. REDUCER

Size (mm)	Pack quantity	Catalogue number	Product Code
1/4" x 1/2"	25	W121	V10 121 01



1 3/4" X 38mm F.I. TO PIPE COUPLER

Size (mm)	Pack quantity	Catalogue number	Product Code
1 3/4"	10	W2710	V10 271 01



GLASS ADAPTORS

Size (mm)	Pack quantity	Catalogue number	Product Code
38	1	W451	V10 451 04
51	1	W452	V10 452 04
76	1	W453	V10 453 04
102	1	W454	V10 454 04



ACCESS PIPES

Size (mm)	Pack quantity	Catalogue number	Product Code
51	1	W902	V10 902 01
76	1	W903	V10 903 01
102	1	W904	V10 904 01



HORIZONTAL/VERTICAL THERMAL STRESS RELIEF UNITS

Size (mm)	Pack quantity	Catalogue number	Product Code
38	1	W801	V10 111 01



HORIZONTAL/VERTICAL THERMAL STRESS RELIEF UNITS

Size (mm)	Pack quantity	Catalogue number	Product Code
51	1	W802	V54 522 01



HORIZONTAL/VERTICAL THERMAL STRESS RELIEF UNITS

Size (mm)	Pack quantity	Catalogue number	Product Code
76	1	W803	V10 803 01
102	1	W804	V10 804 01



FLANGES – BS Table 'D' supplied undrilled

Size (mm)	Pack quantity	Catalogue number	Product Code
38*	1	W101T.D	V10 101 01
51*	1	W102T.D	V10 102 01
76*	1	W103T.D	V10 103 01
102*	1	W104T.D	V10 104 01

* Made to Order (Please refer to our Terms & Conditions).



GASKETS – BS Table 'D'

Size (mm)	Pack quantity	Product Code
38	1	V4 501 10
51	1	V4 501 20
76	1	V4 501 30
102	1	V4 501 40



NUTS

Size (mm)	Pack quantity	Catalogue number	Product Code
38	50	W231	V10 231 01
51	50	W232	V10 232 01
76	25	W233	V10 233 01
102	25	W234	V10 234 01

Vulcathene

Mechanical fittings



NO HEAT OLIVES

Size (mm)	Pack quantity	Catalogue number	Product Code
38*	1	W221	V10 221 11
51*	1	W222	V10 222 11
76	25	W223	V10 223 11
102	25	W224	V10 224 11



BLANKING OFF PLUGS

Size (mm)	Pack quantity	Catalogue number	Product Code
38	10	W241	V10 241 01
51	10	W242	V10 242 01
76	1	W243	V10 243 01
102	1	W244	V10 244 01



SPANNERS

Size (mm)	Pack quantity	Catalogue number	Product Code
38	10	W361	V10 361 01
51	5	W362	V10 362 01
76	5	W363	V10 363 01
102	5	W364	V10 364 01



GROOVE CUTTING TOOLS

Size (mm)	Pack quantity	Catalogue number	Product Code
38	1	W261	V10 261 01
51	1	W262	V10 262 01



GROOVE CUTTING TOOLS

Size (mm)	Pack quantity	Catalogue number	Product Code
76	1	W263	V10 263 01
102	1	W264	V10 264 01



PIPE CUTTERS

Description	Pack qty	Product Code
16-50mm pipe cutter	1	FT 80 00 01
50-125mm pipe cutter	1	FT 80 00 03
110-160mm pipe cutter	1	FT 80 00 09
16-63mm spare cutter wheel	1	FT 80 00 02
50-125mm spare cutter wheel	1	FT 80 00 04



HALF COUPLERS (POLYFUSION)

Size (mm)	Pack quantity	Catalogue number	Product Code
38	10	C130	V5 130 101



BSP COUPLERS (POLYFUSION)

Size (mm)	Pack quantity	Catalogue number	Product Code
38	10	P758	V5 758 101



POLYFUSION WELDING TOOLS

Size (mm)	Pack quantity	Product Code
38	1	V4 400 10

Vulcathene

Enfusion fittings



SINGLE SOCKETS - Long sweep bend

Size (mm)	Pack quantity	Catalogue number	Product Code
38	10	L281	V60 281 01
51	10	L282	V60 282 01
76	1	L283	V60 283 01
102	1	L284	V60 284 01
152	1	L286	V60 286 01



SINGLE SOCKETS - Short sweep bend

Size (mm)	Pack quantity	Catalogue number	Product Code
38	10	L291	V60 291 01
51	10	L292	V60 292 01



LOOSE NUT/SOCKETS - Short sweep bend

Size (mm)	Pack quantity	Catalogue number	Product Code
38	10	L291A	V60 291 11



DOUBLE SOCKETS - Long sweep bend

Size (mm)	Pack quantity	Catalogue number	Product Code
38	10	L171	V60 171 01
51	10	L172	V60 172 01
76	1	L173	V60 173 01
102	1	L174	V60 174 01
152	1	L176	V60 176 01



DOUBLE SOCKETS - Short sweep bend

Size (mm)	Pack quantity	Catalogue number	Product Code
38	10	L181	V60 181 01
51	10	L182	V60 182 01



DOUBLE SOCKETS - 45° slow bend

Size (mm)	Pack quantity	Catalogue number	Product Code
38	10	L191	V60 191 01
51	10	L192	V60 192 01
76	1	L193	V60 193 01
102	1	L194	V60 194 01
152	1	L196	V60 196 01



SINGLE SOCKETS - 45° slow bend

L211/L212/L213/L214/L216

Size (mm)	Pack quantity	Catalogue number	Product Code
38	10	L211	V60 211 01
51	10	L212	V60 212 01
76	1	L213	V60 213 01
102	1	L214	V60 214 01
152	1	L216	V60 216 01



92½° EQUAL SWEEP TEES

Size (mm)	Pack quantity	Catalogue number	Product Code
38	5	L201	V60 201 01
51	5	L202	V60 202 01
76	1	L203	V60 203 01
102	1	L204	V60 204 01



92½° REDUCING SWEEP TEES*

Size (mm)	Pack quantity	Catalogue number	Product Code
51 x 38	5	L2021	V60 202 11
76 x 38	1	L2031	V60 203 11
76 x 51	1	L2032	V60 203 21
102 x 51	1	L2042	V60 204 21

*To make 102x76mm reducing tee use L204 equal tee with L3934 reducer.



45° SINGLE WYES

Size (mm)	Pack quantity	Catalogue number	Product Code
38	10	L371	V60 371 01
51	1	L372	V60 372 01
76	1	L373	V60 373 01
102	1	L374	V60 374 01
152	1	L376	V60 376 01



45° REDUCING WYES

Size (mm)	Pack quantity	Catalogue number	Product Code
51 x 38	1	L3721	V60 372 11
76 x 38	1	L3731	V60 373 11
76 x 51	1	L3732	V60 373 21
102 x 51	1	L3742	V60 374 21
102 x 76	1	L3743	V60 374 31
152 x 51	1	L3762	V60 376 21
152 x 76	1	L3763	V60 376 31
152 x 102	1	L3764	V60 376 41



92½° DOUBLE BRANCHES

Size (mm)	Pack quantity	Catalogue number	Product Code
51	1	L352	V60 352 01
76	1	L353	V60 353 01
102	1	L354	V60 354 01



U-BENDS

Size (mm)	Pack quantity	Catalogue number	Product Code
38*	1	L1011	V60 101 11
51*	1	L1012	V60 101 21

*P traps in 38mm & 51mm sizes can be made by adding 1 x L28 series single socket bend to the U bend; P traps in 76mm, 102mm & 152mm sizes can be made using 2 x L28 series single socket bends plus 1 x L17 series double socket.



SLIP COUPLERS

Size (mm)	Pack quantity	Catalogue number	Product Code
102	1	L164(S)	V67 164 01
152	1	L166(S)	V64 166 01



LINE COUPLERS

Size (mm)	Pack quantity	Catalogue number	Product Code
38	10	L161	V60 161 01
51	10	L162	V60 162 01
76	1	L163	V60 163 01
102	1	L164	V60 164 01
152	1	L166	V60 166 01



GLASS ADAPTORS

Size (mm)	Pack quantity	Catalogue number	Product Code
38*	1	L451	V60 451 04
51*	1	L452	V60 452 04
76*	1	L453	V60 453 04
102*	1	L454	V60 454 04

* Made to Order (Please refer to our Terms & Conditions).



M.I. TO PIPE COUPLERS

Size (mm)	Pack quantity	Catalogue number	Product Code
38	10	L141	V60 141 01
51	10	L142	V60 142 01



REDUCING COUPLERS*

Size (mm)	Pack quantity	Catalogue number	Product Code
51 x 38	25	L3912	V60 391 21
76 x 51	10	L3923	V60 392 31
102 x 51	5	L3924	V60 392 41
102 x 76	1	L3934	V60 393 41
152 x 102	1	L3946	V60 394 61

*76mm x 38mm reducer: Use L3923 reducer + L3912 reducer

102mm x 38mm reducer: Use L3924 reducer + L3912 reducer

152mm x 38mm reducer: Use L3946 reducer + L3924 reducer + L3912 reducer

152mm x 51mm reducer: Use L3946 reducer + L3924 reducer

152mm x 76mm reducer: Use L3946 reducer + L3934 reducer



F.I. TO PIPE COUPLERS

Size (mm)	Pack quantity	Catalogue number	Product Code
76	1	L803	V10 803 01
102	1	L804	V10 804 01
152	1	L806	V60 806 01



HORIZONTAL/VERTICAL THERMAL STRESS RELIEF UNITS

Size (mm)	Pack quantity	Catalogue number	Product Code
38	1	L801	V60 801 01



HORIZONTAL/VERTICAL THERMAL STRESS RELIEF UNITS

Size (mm)	Pack quantity	Catalogue number	Product Code
51	1	L802	V60 802 01



HORIZONTAL/VERTICAL THERMAL STRESS RELIEF UNITS

Size (mm)	Pack quantity	Catalogue number	Product Code
76	1	L803	V10 803 01
102	1	L804	V10 804 01
152	1	L806	V60 806 01

*Now supplied spigot ended.

Vulcathene

Enfusion fittings



FLANGES

Size (mm)	Pack quantity	Catalogue number	Product Code
UNDRILLED			
38	1	L361	V60 401 01
51	1	L362	V60 402 01
76	1	L363	V60 403 01
102	1	L364	V60 404 01
152	1	L366	V60 406 01



CLEANOUT PLUGS*

Size (mm)	Pack quantity	Catalogue number	Product Code
38	5	L241	V60 241 01
51	5	L242	V60 242 01
76	1	L243	V60 243 01
102	1	L244	V60 244 01

*Note: for 152mm cleanout use L3946 reducer with L244 cleanout plug.



ENFUSION 'HAND HELD' ELECTROFUSION UNIT

Pack quantity	Catalogue number	Product Code
1	L2601	V6ECU001



CLAMPS

Size (mm)	Pack quantity	Catalogue number	Product Code
38	1	L261	V62 610 14
51	1	L262	V62 610 24
76	1	L263	V62 610 34
102	1	L264	V62 610 44
152	1	L265	V62 610 64



LINK CABLE

Pack quantity	Catalogue number	Product Code
1	L2610	C53EN003



PIPE SCRAPER

Size (mm)	Pack quantity	Product Code
Pipe scraper	-	C53MJ001
Replacement bades	2 per pack	C53MJ002

TERMINAL PIN ADAPTOR

Pack quantity	Product Code
10	C3370890

*Terminal pin adaptors allow easier access to fitting terminal pins where access is restricted.

Enhance your **knowledge** of Vulcathene with our **e-learning platform!**

To register for free please visit:
alixisacademy.co.uk/registration



A full range of Vultex Labline Service Controls & Spares, are available via Arboles UK. Contact their Customer Service Team for further information on +44 (0) 1204 388814

SuperFlo ABS



SuperFlo ABS

Metric pipe & solvent weld fittings



METRIC PIPE SYSTEM – Plain PN10

Diameter (mm)	Standard length in metres	Product Code
16	5	11 555 305
20	5	11 555 306
25	5	11 555 307
32	5	11 555 308
40	5	11 555 309
50	5	11 555 310
63	5	11 555 311
75	5	11 555 312
90	5	11 555 313
110	5	11 555 314
125	5	11 555 315
140	5	11 555 316
160	5	11 555 317
200	5	11 555 318
225	5	11 555 319
250	5	11 555 320
315**	5	11 555 323
20*	6	11 551 306
25	6	11 551 307
32	6	11 551 308
40	6	11 551 309
50	6	11 551 310
63	6	11 551 311
75	6	11 551 312
90	6	11 551 313
110	6	11 551 314
125*	6	11 551 315
140*	6	11 551 316
160*	6	11 551 317
200*	6	11 551 318
225*	6	11 551 319
250*	6	11 551 320
315**	6	11 551 323

* Made to Order (Please refer to our Terms & Conditions).

** 315mm is PN8 rated.



SOCKETS

Size (mm)	Standard pack quantity	Product Code
16	10	11 100 305
20	10	11 100 306
25	10	11 100 307
32	10	11 100 308
40	10	11 100 309
50	10	11 100 310
63	5	11 100 311
75	1	11 100 312
90	1	11 100 313
110	1	11 100 314
125	1	11 100 315
140	1	11 100 316
160	1	11 100 317
200	1	11 100 318
225	1	11 100 319
250	1	11 100 320
315	1	11 100 323



REDUCING BUSHES

Size (mm)	Standard pack quantity	Product Code
20 x 16	10	11 109 412
25 x 20	10	11 109 415
32 x 16	10	11 09 417
32 x 25	10	11 109 419
40 x 32	10	11 109 423
50 x 20	10	11 109 424
50 x 25	10	11 109 425
50 x 32	10	11 109 426
50 x 40	10	11 109 427
63 x 25	10	11 109 429
63 x 32	10	11 109 430
63 x 50	10	11 109 432
75 x 63	5	11 109 438
90 x 50	5	11 109 442
90 x 63	5	11 109 443
90 x 75	5	11 109 444
110 x 63	1	11 109 449
110 x 90	1	11 109 451
125 x 110	1	11 109 459
140 x 125	1	11 109 467
160 x 90	1	11 109 473
160 x 110	1	11 109 474
160 x 140	1	11 109 476
200 x 160	1	11 109 487
225 x 160	1	11 109 495
225 x 200	1	11 109 496
250 x 225	1	11 109 499
315 x 250	1	11 109 503



REDUCERS – Plain/Spigot x plain

Size (mm)	Standard pack quantity	Product Code
(25 or 20) x 16	10	11 114 412
(32 or 25) x 20	10	11 114 415
(40 or 32) x 25	10	11 114 419
(50 or 40) x 32	10	11 114 423
(63 or 50) x 40	5	11 114 427
(75 or 63) x 50	5	11 114 432
(90 or 75) x 63	1	11 114 438
(110 or 90) x 75	1	11 114 444
(125 or 110) x 90	1	11 114 451
(140 or 125) x 110	1	11 114 459
(160 or 140) x 125	1	11 114 467
(200 or 160) x 140	1	11 114 476
(225 or 200) x 160	1	11 114 487



TEES 45° – Plain

Size (mm)	Standard pack quantity	Product Code
20	5	11 418 306
25	5	11 418 307
32	5	11 418 308
40	5	11 418 309
50	5	11 418 310
63	1	11 418 311

SuperFlo ABS

Metric solvent weld fittings



ELBOWS 45°

Size (mm)	Standard pack quantity	Product Code
16	10	11 119 305
20	10	11 119 306
25	10	11 119 307
32	10	11 119 308
40	10	11 119 309
50	10	11 119 310
63	5	11 119 311
75	1	11 119 312
90	1	11 119 313
110	1	11 119 314
125	1	11 119 315
140	1	11 119 316
160	1	11 119 317
200	1	11 119 318
225	1	11 119 319
250	1	11 119 320
315	1	11 119 323



ELBOWS 90°

Size (mm)	Standard pack quantity	Product Code
16	10	11 115 305
20	10	11 115 306
25	10	11 115 307
32	10	11 115 308
40	10	11 115 309
50	10	11 115 310
63	5	11 115 311
75	1	11 115 312
90	1	11 115 313
110	1	11 115 314
125	1	11 115 315
140	1	11 115 316
160	1	11 115 317
200	1	11 115 318
225	1	11 115 319
250	1	11 115 320
315	1	11 115 323



TEES 90° – Equal

Size (mm)	Standard pack quantity	Product Code
16	10	11 122 305
20	10	11 122 306
25	10	11 122 307
32	10	11 122 308
40	10	11 122 309
50	5	11 122 310
63	5	11 122 311
75	1	11 122 312
90	1	11 122 313
110	1	11 122 314
125	1	11 122 315
140	1	11 122 316
160	1	11 122 317
200	1	11 122 318
225	1	11 122 319
250	1	11 122 320
315	1	11 122 323



TEES 90° – Swept

Size (mm)	Standard pack quantity	Product Code
32	10	11 148 308
50	10	11 148 310
63	5	11 148 311
75	1	01 148 108
110	1	11 148 314



TEES 90° – Reducing

Size (mm)	Standard pack quantity	Product Code
25 x 20	10	11 124 415
32 x 20	10	11 124 418
32 x 25	10	11 124 419
40 x 20	10	11 124 421
40 x 25	10	11 124 422
50 x 20	5	11 124 424
50 x 25	5	11 124 425
50 x 32	5	11 124 426
63 x 25	5	11 124 429
63 x 32	5	11 124 430
75 x 32	1	11 124 435
75 x 40	1	11 124 436
75 x 50	1	11 124 437
75 x 63	1	11 124 438
90 x 40	1	11 124 441
90 x 50	1	11 124 442
90 x 63	1	11 124 443
110 x 63	1	11 124 449
110 x 75	1	11 124 450



BENDS 90°

Size (mm)	Standard pack quantity	Product Code
20	10	11 118 306
25	10	11 118 307
32	10	11 118 308
40	5	11 118 309
50	1	11 118 310
63	1	11 118 311
75	1	11 118 312
90	1	11 118 313
110	1	11 118 314

SuperFlo ABS

Metric solvent weld fittings



FABRICATED BENDS 90° – Plain

Size (mm)	Standard pack quantity	Product Code
75*	1	11 309 312
125*	1	11 309 315
140*	1	11 309 316
160*	1	11 309 317
200*	1	11 309 318
225*	1	11 309 319

* Made to Order (Please refer to our Terms & Conditions).

Note: Special angled bends can be supplied to order: Angles between 0° and 90° – POA.



CAPS – Plain

Size (mm)	Standard pack quantity	Product Code
16	10	11 149 305
20	10	11 149 306
25	10	11 149 307
32	10	11 149 308
40	10	11 149 309
50	10	11 149 310
63	5	11 149 311
75	5	11 149 312
90	5	11 149 313
110	1	11 149 314



SOCKET UNIONS

Size (mm)	Standard pack quantity	Product Code
16	10	11 205 305
20	10	11 205 306
25	10	11 205 307
32	10	11 205 308
40	5	11 205 309
50	5	11 205 310
63	5	11 205 311
75	5	11 205 312
90	1	11 205 313
110	1	11 205 314

EPDM seal as standard.



IMPERIAL/METRIC SOCKET ADAPTORS – Plain

Size (mm)	Standard pack quantity	Product Code
1/2 x 20	10	11 345 102
3/4 x 25	10	11 345 103
1 x 32	10	11 345 104
1 1/4 x 40	10	11 345 105
1 1/2 x 50	10	11 345 106
2 x 63	5	11 345 107
2 1/2 x 75	1	11 100 312
3 x 90	1	11 345 109
4 x 110	1	11 345 110
6 x 160	1	11 345 112



MALE THREADED ADAPTORS – BSP taper male thread

Size (mm)	Standard pack quantity	Product Code
16 x 12 x 3/8"	10	11 151 331
20 x 16 x 3/8"	10	11 151 332
20 x 16 x 1/2"	10	11 151 333
20 x 16 x 3/4"	10	11 151 327
25 x 20 x 1/2"	10	11 151 334
25 x 20 x 3/4"	10	11 151 335
32 x 25 x 1/2"	10	11 151 352
32 x 25 x 3/4"	10	11 151 336
32 x 25 x 1"	10	11 151 337
40 x 32 x 1"	10	11 151 338
40 x 32 x 1 1/4"	10	11 151 339
50 x 40 x 1 1/4"	5	11 151 340
50 x 40 x 1 1/2"	5	11 151 341
63 x 50 x 1 1/2"	5	11 151 342
63 x 50 x 2"	5	11 151 343
75 x 63 x 2"	5	11 151 345



FEMALE THREADED ADAPTORS – BSP taper female threaded reinforced

Size (mm)	Standard pack quantity	Product Code
16 x 12 x 3/8"	10	11 153 331
20 x 16 x 1/2"	10	11 153 333
25 x 20 x 3/4"	10	11 153 335
32 x 25 x 1"	10	11 153 337
40 x 32 x 1 1/4"	5	11 153 339
50 x 40 x 1 1/2"	5	11 153 341
63 x 50 x 2"	5	11 153 343



HOSE ADAPTORS – Spigot end

Size (mm)	Standard pack quantity	Product Code
16	10	11 158 305
20	10	11 158 306
25	10	11 158 307
32	10	11 158 308



FEMALE COMPOSITE UNIONS – ABS/Brass, BSP parallel female

Size (mm)	Standard pack quantity	Product Code
16 x 3/8"	10	11 216 305
20 x 1/2"	10	11 222 306
25 x 3/4"	10	11 222 307
32 x 1"	10	11 222 308
40 x 1 1/4"	5	11 222 309
50 x 1 1/2"	5	11 222 310
63 x 2"	5	11 222 311

SuperFlo ABS

Metric solvent weld fittings



MALE COMPOSITE UNIONS – ABS/Brass, BSP taper male thread

Size (mm)	Standard pack quantity	Product Code
16 x 3/8"	10	11 217 305
20 x 1/2"	10	11 223 306
25 x 3/4"	10	11 223 307
32 x 1"	10	11 223 308
40 x 1 1/4"	5	11 223 309
50 x 1 1/2"	5	11 223 310
63 x 2"	5	11 223 311



SS FEMALE COMPOSITE UNIONS – ABS/Stainless Steel 316L, BSP parallel female

Size (mm)	Standard pack quantity	Product Code
20 x 1/2"	10	11 218 306
25 x 3/4"	10	11 218 307
32 x 1"	10	11 218 308
40 x 1 1/4"	5	11 218 309
50 x 1 1/2"	5	11 218 310
63 x 2"	5	11 218 311



ABS FLEXIBLE BRAIDED HOSES* – Plain spigot x BSP

Size (mm)	Standard pack quantity	Product Code
20 1/2" x 300mm	1	11 450 306
25 3/4" x 300mm	1	11 450 307
32 1" x 300mm	1	11 450 308
20 1/2" x 600mm	1	11 451 306
25 3/4" x 600mm	1	11 451 307
32 1" x 600mm	1	11 451 308

* Made to Order (Please refer to our Terms & Conditions).



SS MALE COMPOSITE UNIONS – ABS/Stainless Steel 316L, BSP taper male

Size (mm)	Standard pack quantity	Product Code
20 x 1/2"	10	11 219 306
25 x 3/4"	10	11 219 307
32 x 1"	10	11 219 308
40 x 1 1/4"	5	11 219 309
50 x 1 1/2"	5	11 219 310
63 x 2"	5	11 219 311



STUB FLANGES – Serrated face

Size (mm)	Standard pack quantity	Product Code
16	10	11 135 305
20	10	11 135 306
25	10	11 135 307
32	10	11 135 308
40	10	11 135 309
50	5	11 135 310
63	5	11 135 311
75	5	11 135 312
90	1	11 135 313
110	1	11 135 314
125	1	11 135 315
140	1	11 135 316
160	1	11 135 317
200*	1	11 135 318
225	1	11 135 319
250	1	11 135 320
315	1	11 135 323

*The 200mm (NW175) stub flange supplied by Durapipe when used in conjunction with backing ring Code number 421 318 and 420 318 has a bolt circle diameter which matches 225mm (NW200) valves and fittings (295mm).



BLANK FLANGES

Size (mm)	Standard pack quantity	Product Code
Drilled to EN1029 PN16 (formerly BS4504)		
32	5	11 323 308
40	5	11 323 309
50	5	11 323 310
63	5	11 323 311
75	5	11 323 312
90	1	11 323 313
110	1	11 323 314
125	1	11 323 315
140	1	11 323 316
160	1	11 323 317

Note: Durapipe backing rings must be used in conjunction with blank flanges.

SuperFlo ABS

Metric solvent weld fittings & accessories



SOCKET UNION PLAIN ADAPTOR

Size (mm)	Standard pack quantity	Product Code
16	10	11 206 305
20	10	11 206 306
25	10	11 206 307
32	10	11 206 308
40	5	11 206 309
50	5	11 206 310
63	5	11 206 311



SOCKET UNION THREADED ADAPTOR

Size (mm)	Standard pack quantity	Product Code
25	10	11 207 307
32	10	11 207 308
40	5	11 207 309
50	5	11 207 310
63	5	11 207 311



SOCKET UNION NUT

Size (mm)	Standard pack quantity	Product Code
16	10	11 208 305
20	10	11 208 306
25	10	11 208 307
32	10	11 208 308
40	5	11 208 309
50	5	11 208 310
63	5	11 208 311



SOCKET END PLAIN

Size (mm)	Standard pack quantity	Product Code
20	10	92 878 306
25	10	92 878 307
32	10	92 878 308
40	5	92 878 309
50	5	92 878 310
63	5	92 878 311



BACKING RINGS – Galvanised mild steel

Size (mm)	Standard pack quantity	Product Code
Drilled to EN1029 PN10/PN16 (formerly BS4504)		
16	1	13 421 305
20	1	13 421 306
25	1	13 421 307
32	1	13 421 308
40	1	13 421 309
50	1	13 421 310
63	1	13 421 311
75	1	13 421 312
90	1	13 421 313
110	1	13 421 314
125	1	13 421 315
140	1	13 421 316
160	1	13 421 317
Drilled to EN1029 PN10 (formerly BS4504)		
200	1	13 421 318
225	1	13 421 319
250	1	13 421 320
315	1	13 421 323
Drilled to EN1029 PN16 (formerly BS4504)		
200	1	13 420 318
225	1	13 420 319
250	1	13 420 320
315	1	13 420 323
Drilled to ANSI CLASS 150		
20	1	13 448 306
25	1	13 448 307
32	1	13 448 308
40	1	13 448 309
50	1	13 448 310
63	1	13 448 311
75	1	13 448 312
90	1	13 448 313
110	1	13 448 314

*The 200mm (NW175) stub flange supplied by Durapipe when used in conjunction with backing ring; Code number 421 318 and 420 318 has a bolt circle diameter which matches 225mm (NW200) valves and fittings (295mm).



FLAT GASKETS/STUB FLANGES

Size (mm)	Standard pack quantity	Product Code
16	1	13 411 305
20	1	13 411 306
25	1	13 411 307
32	1	13 411 308
40	1	13 411 309
50	1	13 411 310
63	1	13 411 311
75	1	13 411 312
90	1	13 411 313
110	1	13 411 314
125	1	13 411 315
140	1	13 411 316
160	1	13 411 317
200	1	13 411 318
225	1	13 411 319
250	1	13 431 320
315	1	13 411 323



VALVE SUPPORT PLATES GALVANISED MILD STEEL

Size (mm)	Standard pack quantity	Product Code
16	1	31 459 305
20	1	31 459 306
25	1	31 459 307
32	1	31 459 308
50	1	31 459 310
63	1	31 459 311
75	1	31 459 312
90	1	31 459 313
110	1	31 459 314

SuperFlo ABS

Metric valves & accessories



VKD DOUBLE UNION BALL VALVES MANUAL – EPDM seals

Size (mm)	Standard pack quantity	Product Code
16	1	H0 DKA 305
20	1	H0 DKA 306
25	1	H0 DKA 307
32	1	H0 DKA 308
40	1	H0 DKA 309
50	1	H0 DKA 310
63	1	H0 DKA 311

Note: FKM seals available on request



LOCKABLE VKD DOUBLE UNION BALL VALVE MANUAL – EPDM seals

Size (mm)	Standard pack quantity	Product Code
16	1	H0 DLA 305
20	1	H0 DLA 306
25	1	H0 DLA 307
32	1	H0 DLA 308
40	1	H0 DLA 309
50	1	H0 DLA 310
63	1	H0 DLA 311

Note: FKM seals available on request



VKD DOUBLE UNION BALL VALVES MANUAL – EPDM seals

Size (mm)	Standard pack quantity	Product Code
75	1	H0 DKA 312
90	1	H0 DKA 313
110	1	H0 DKA 314

Note: VKD ball valves are available with flanged ends (ISO-DIN) on request. Please order via Code H0 DKA F**



TKD 3-WAY BALL VALVES T-PORT PLAIN FEMALE ENDS – EPDM seals

Size (mm)	Standard pack quantity	Product Code
20	1	H0 TTA 306
25	1	H0 TTA 307
32	1	H0 TTA 308
40	1	H0 TTA 309
50	1	H0 TTA 310
63	1	H0 TTA 311

TKD 3-WAY BALL VALVES T-PORT PLAIN FEMALE ENDS – EPDM seals

Size (mm)	Standard pack quantity	Product Code
20	1	H0 LTA 306
25	1	H0 LTA 307
32	1	H0 LTA 308
40	1	H0 LTA 309
50	1	H0 LTA 310
63	1	H0 LTA 311

Lockable Handle Option available upon request: Please order Code reference 'TLA'



VXE EASYFIT DOUBLE UNION BALL VALVES MANUAL – EPDM seals

Size (mm)	Standard pack quantity	Product Code
20	1	H0 XEA 306
25	1	H0 XEA 307
32	1	H0 XEA 308
40	1	H0 XEA 309
50	1	H0 XEA 310
63	1	H0 XEA 311

Note: FKM seals available on request.



SET OF TRANSPARENT SERVICE PLUGS AND WHITE PVC TAG HOLDERS – For insertion in handle for VXE Easyfit valve customisation

Size (mm)	Standard pack quantity	Product Code
16-20 / 1/2	20	LCE020
25/3/4	20	LCE025
32 / 1	20	LCE032
40 / 1 1/4	20	LCE040
50 / 1 1/2	20	LCE050
63 / 2	20	LCE063

Note: FKM seals available on request



DIE CUT LABELS PLUS SOFTWARE – White waterproof A4 sheets and freeware editing software to be used with inkjet printers for VXE Easyfit valve customisation

Size (mm/inch)	No. of sheets	Total labels	Product Code
16-20 / 1/2	10	500	LSE020
25/3/4	10	500	LSE025
32 / 1	10	500	LSE032
40 / 1 1/4	10	500	LSE040
50 / 1 1/2	10	400	LSE050
63 / 2	10	400	LSE063



VKR METERING BALL VALVES PLAIN FEMALE ENDS – EPDM seals

Size (mm)	Standard pack quantity	Product Code
16	1	H0 MBA 305
20	1	H0 MBA 306
25	1	H0 MBA 307
32	1	H0 MBA 308
40	1	H0 MBA 309
50	1	H0 MBA 310
63	1	H0 MBA 311

SuperFlo ABS

Metric valves & accessories



SX EASYFIT BALL CHECK VALVES PLAIN FEMALE ENDS - EPDM seals

Size (mm)	Standard pack quantity	Product Code
20	1	H0 SXA 306
25	1	H0 SXA 307
32	1	H0 SXA 308
40	1	H0 SXA 309
50	1	H0 SXA 310
63	1	H0 SXA 311

SX ball check valve is also available with FKM seals.



SX EASYFIT AIR RELEASE VALVES PLAIN FEMALE ENDS - EPDM seals

Size (mm)	Standard pack quantity	Product Code
20	1	H0 SAA 306
25	1	H0 SAA 307
32	1	H0 SAA 308
40	1	H0 SAA 309
50	1	H0 SAA 310
63	1	H0 SAA 311

Note: FKM seals available on request



UV Y-TYPE STRAINERS - Plain ends - EPDM seals

Size (mm)	Standard pack quantity	Product Code
20	1	H0 UVA 306
25	1	H0 UVA 307
32	1	H0 UVA 308
40	1	H0 UVA 309
50	1	H0 UVA 310
63	1	H0 UVA 311

Note: FKM seals available on request



DIALOCK® DIAPHRAGM VALVES MANUAL - plain female ends - EPDM

Size (mm)	Standard pack quantity	Product Code
20	1	H0 DVA 306
25	1	H0 DVA 307
32	1	H0 DVA 308
40	1	H0 DVA 309
50	1	H0 DVA 310
63	1	H0 DVA 311

FKM or PTFE seal options available upon request.

Note: Larger sizes available upon request.
(Minimum order quantity will apply)



LR PRESSURE LOADING/RELIEF VALVES - Plain Union Ends - EPDM Seals

Size (mm)	Standard pack quantity	Product Code
16	1	H0 LRA 305
20	1	H0 LRA 306
25	1	H0 LRA 307
32	1	H0 LRA 308
40	1	H0 LRA 309
50	1	H0 LRA 310
63	1	H0 LRA 311

FKM or PTFE seal options available upon request.



FK BUTTERFLY VALVES - Glass reinforced Polypropylene with ABS disc, EPDM liner. Lever operated

Size (mm)	Standard pack quantity	Product Code
50	1	H0 FKA 106
63	1	H0 FKA 107
75	1	H0 FKA 108
90	1	H0 FKA 109
110	1	H0 FKA 110
140	1	H0 FKA 111
160	1	H0 FKA 112
225	1	H0 FKA 113

Note: FKM Liner available on request



FK BUTTERFLY VALVES - with gear box

Size (mm)	Standard pack quantity	Product Code
75	1	HV FKA 108
90	1	HV FKA 109
110	1	HV FKA 110
140	1	HV FKA 111
160	1	HV FKA 112
225	1	HV FKA 113
250	1	HV FKA 114
315	1	HV FKA 115

Note: FKM Liner available on request



RUBBER LINED PIPE CLIPS

Size (mm)	Thread	Standard pack quantity	Product Code
16	M10	50	FT PC 1600
20	M10	50	FT PC 2000
25	M10	50	FT PC 2500
32	M10	50	FT PC 3200
40	M10	50	FT PC 4000
50	M10	50	FT PC 5000
63	M10	50	FT PC 6300
75	M10	50	FT PC 7500
90	M10	50	FT PC 9000
110	M10	50	FT PC 1100
160	M10	50	FT PC 1601

SuperFlo ABS

Imperial pipe & solvent weld fittings



PIPE - ABS Class C (9 bar)

Pipe diameter (inch)	Standard length in metres	Product Code
1	6	01 511 104
1¼	6	01 511 105
1½	6	01 511 106
2	6	01 511 107
2½	6	11 551 312
3	6	01 511 109
4	6	01 511 110
5	6	11 551 316
6	6	01 511 112
8	6	01 511 113

Note: 2½" and 5" pipes are 10 bar rated.



PIPE - ABS Class D (12 bar)

Pipe diameter (inch)	Standard length in metres	Product Code
6	6	01 512 112



PIPE - ABS Class E (15 bar)

Pipe diameter (inch)	Standard length in metres	Product Code
½	6	01 513 102
¾	6	01 513 103
1	6	01 513 104
1¼	6	01 513 105
1½	6	01 513 106
2	6	01 513 107
3	6	01 513 109
4	6	01 513 110



PIPE - ABS Class T for threading (12 bar after threading)

Size (inch)	Standard pack quantity	Product Code
½	6	01 514 102
¾	6	01 514 103
1	6	01 514 104
1¼	6	01 514 105
1½	6	01 514 106
2	6	01 514 107



SOCKETS PLAIN

Size (inch)	Standard pack quantity	Product Code
½	10	01 100 102
¾	10	01 100 103
1	10	01 100 104
1¼	10	01 100 105
1½	10	01 100 106
2	5	01 100 107
2½	1	11 100 312
3	1	01 100 109
4	1	01 100 110
5	1	11 100 316
6	1	01 100 112
8	1	01 100 113



REDUCING SOCKETS - Plain

Size (inch)	Standard pack quantity	Product Code
¾ x ½	10	01 114 122
1 x ¾	10	01 114 124
1¼ x 1	10	01 114 125
1½ x 1¼	10	01 114 127
2 x 1½	5	01 114 130
3 x 2	1	01 114 135
4 x 3	1	01 114 141
6 x 4	1	01 114 147
8 x 6	1	01 114 152



REDUCING BUSHES - Plain

Size (inch)	Standard pack quantity	Product Code
¾ x ½	10	01 109 122
1 x ½	10	01 109 123
1 x ¾	10	01 109 124
1¼ x ½	10	01 109 116
1¼ x ¾	10	01 109 117
1¼ x 1	10	01 109 125
1½ x ½	10	01 109 118
1½ x ¾	10	01 109 119
1½ x 1	10	01 109 126
1½ x 1¼	10	01 109 127
2 x ¾	10	01 109 120
2 x 1	10	01 109 128
2 x 1¼	10	01 109 129
2 x 1½	10	01 109 130
2½ x 2	5	01 109 131
3 x 1½	5	01 109 134
3 x 2	5	01 109 135
3 x 2½	5	01 109 136
4 x 3	1	01 109 141
5 x 4	1	01 329 142
6 x 4	1	01 109 147
6 x 5	1	01 329 148
8 x 6	1	01 109 152

SuperFlo ABS

Imperial solvent weld fittings



ELBOWS 45° – Plain

Size (inch)	Standard pack quantity	Product Code
1/2	10	01 119 102
3/4	10	01 119 103
1	10	01 119 104
1 1/4	10	01 119 105
1 1/2	10	01 119 106
2	5	01 119 107
2 1/2	1	11 119 312
3	1	01 119 109
4	1	01 119 110
5	1	11 119 316
6	1	01 119 112
8	1	01 119 113



ELBOWS 90° – Plain

Size (inch)	Standard pack quantity	Product Code
1/2	10	01 115 102
3/4	10	01 115 103
1	10	01 115 104
1 1/4	10	01 115 105
1 1/2	10	01 115 106
2	5	01 115 107
2 1/2	1	11 115 312
3	1	01 115 109
4	1	01 115 110
5	1	11 115 316
6	1	01 115 112
8	1	01 115 113



TEES 45° – Plain

Size (inch)	Standard pack quantity	Product Code
1/2	5	01 128 102
3/4	5	01 128 103
1	5	01 128 104
1 1/4	5	01 128 105
1 1/2	5	01 128 106
2	1	01 128 107



TEES 90° – Plain

Size (inch)	Standard pack quantity	Product Code
1/2	10	01 122 102
3/4	10	01 122 103
1	10	01 122 104
1 1/4	10	01 122 105
1 1/2	5	01 122 106
2	5	01 122 107
2 1/2	1	11 122 312
3	1	01 122 109
4	1	01 122 110
5	1	11 122 316
6	1	01 122 112
8	1	01 122 113



TEES 90° SWEPT – Plain

Size (inch)	Standard pack quantity	Product Code
1	10	01 148 104
1 1/2	5	01 148 106
2	5	01 148 107
2 1/2	1	01 148 108
4	1	01 148 110



TEES 90° – Reducing

Size (inch)	Standard pack quantity	Product Code
3/4 x 1/2	5	01 124 122
1 x 1/2	5	01 124 123
1 x 3/4	5	01 124 124



BENDS 22 1/2° – Long radius

Size (inch)	Standard pack quantity	Product Code
1"	1	01 311 104
1 1/2"	1	01 311 106
2"	1	01 311 107
2 1/2"	1	11 311 312
3"	1	01 311 109
4"	1	01 311 110
5"	1	11 311 316
6"	1	01 311 112
8"	1	01 311 113

* Made to Order (Please refer to our Terms & Conditions).

Note: Special angled bends can be supplied by order. Angles between 0° and 90° – POA.



BENDS 45° – Long radius

Size (inch)	Standard pack quantity	Product Code
1"	1	01 310 104
1 1/2"	1	01 310 106
2"	1	01 310 107
2 1/2"	1	11 310 312
3"	1	01 310 109
4"	1	01 310 110
5"	1	11 310 316
6"	1	01 310 112
8"	1	01 310 113

SuperFlo ABS

Imperial solvent weld fittings



BENDS 90° – Long radius

Size (inch)	Standard pack quantity	Product Code
3	1	01 309 109
4	1	01 309 110
5	1	11 309 316
6	1	01 309 112
8	1	01 309 113



BENDS 90° – Short radius

Size (inch)	Standard pack quantity	Product Code
1/2	10	01 118 103
1	10	01 118 104
1 1/4	5	01 118 105
1 1/2	1	01 118 106
2	1	01 118 107
2 1/2	1	11 118 312
3	1	01 118 109
4	1	01 118 110



SADDLES – Plain

Size (inch)	Standard pack quantity	Product Code
2 x 1 1/4	10	01 126 129
3 x 1 1/2	1	01 126 134
4 x 2	1	01 126 140
6 x 2	1	01 126 146



END CAPS – Plain

Size (inch)	Standard pack quantity	Product Code
1/2	10	01 140 102
3/4	10	01 140 103
1	10	01 140 104
1 1/4	10	01 140 105
1 1/2	10	01 140 106
2	5	01 140 107
2 1/2	5	11 149 312
3	5	01 140 109
4	1	01 140 110



SOCKET UNIONS – Plain EPDM

Size (inch)	Standard pack quantity	Product Code
1/2	10	01 205 102
3/4	10	01 205 103
1	10	01 205 104
1 1/4	5	01 205 105
1 1/2	5	01 205 106
2	5	01 205 107
2 1/2	5	11 205 312
3	1	01 205 109
4	1	01 205 110



SOCKET UNIONS – Plain FKM

Size (inch)	Standard pack quantity	Product Code
1/2	10	01 204 103
3/4	10	01 204 104
1	5	01 204 105
1 1/4	5	01 204 106
1 1/2	5	01 204 107
2	5	11 204 312
2 1/2	1	01 204 109
3"	1	01 204 110
4"	1	01 205 110

3" and 4" are class C rated. 2 1/2" is PN10 rated. EPDM seal as standard



IMPERIAL/METRIC SOCKET ADAPTORS – Plain

Size (inch)	Standard pack quantity	Product Code
1/2 x 20	10	11 345 102
3/4 x 25	10	11 345 103
1 x 32	10	11 345 104
1 1/4 x 40	10	11 345 105
1 1/2 x 50	10	11 345 106
2 x 63	5	11 345 107
2 1/2 x 75	1	11 100 312
3 x 90	1	11 345 109
4 x 110	1	11 345 110
6 x 160	1	11 345 112



SOCKETS – Plain/female BSP thread

Size (inch)	Standard pack quantity	Product Code
1/2	10	01 101 102
3/4	10	01 101 103
1	10	01 101 104
1 1/4	10	01 101 105
1 1/2	10	01 101 106
2	5	01 101 107
3	1	01 101 109

SuperFlo ABS

Imperial solvent weld fittings



REDUCING BUSHES – Plain/female BSP thread

Size (inch)	Standard pack quantity	Product Code
3/4 x 1/2	10	01 111 121
1 x 1/2	10	01 111 122
1 x 3/4	10	01 111 124



ELBOWS 90° – Plain/female BSP thread

Size (inch)	Standard pack quantity	Product Code
1/2	10	01 116 102
3/4	10	01 116 103
1	10	01 116 104
1 1/2	5	01 116 106
2	5	01 116 107



MALE THREADED ADAPTORS – Plain/female BSP thread

Size (inch)	Standard pack quantity	Product Code
1/2	10	01 151 102
3/4	10	01 151 103
1	10	01 151 104
1 1/4	10	01 151 105
1 1/2	5	01 151 106
2	5	01 151 107



FEMALE THREADED ADAPTORS - Plain spigot end/female BSP thread

Size (inch)	Standard pack quantity	Product Code
1/2	10	01 153 102
3/4	10	01 153 103
1	10	01 153 104
1 1/4	10	01 153 105
1 1/2	5	01 153 106
2	5	01 153 107



HEXAGON NIPPLES – Plain spigot/ male BSP thread

Size (inch)	Standard pack quantity	Product Code
1/2	10	01 107 102
3/4	10	01 107 103
1	10	01 107 104
1 1/4	10	01 107 105
1 1/2	5	01 107 106
2	5	01 107 107



BARREL NIPPLES – Plain spigot/ male BSP thread

Size (inch)	Standard pack quantity	Product Code
1/2	1	01 316 102
3/4	1	01 316 103
1	1	01 316 104
1 1/4	1	01 316 105
1 1/2	1	01 316 106
2	1	01 316 107
2 1/2	1	01 316 108
3	1	01 316 109
4	1	01 316 110



HOSE ADAPTORS – Male BSP thread/hose tail

Size (inch)	Standard pack quantity	Product Code
1/2	10	01 157 102
3/4	10	01 157 103
1	10	01 157 104



TANK CONNECTORS – Plain spigot/ male BSP thread

Size (inch)	Standard pack quantity	Product Code
1/2	10	01 235 102
3/4	10	01 235 103
1	10	01 235 104
1 1/4	10	01 235 105
1 1/2	10	01 235 106
2	5	01 235 107
2 1/2	1	01 235 108
3	1	01 235 109
4	1	01 235 110

SuperFlo ABS

Imperial solvent weld fittings



COMPOSITE UNIONS – Plain/brass female parallel BSP thread

Size (inch)	Standard pack quantity	Product Code
1/2	10	01 222 102
3/4	10	01 222 103
1	10	01 222 104
1 1/4	5	01 222 105
1 1/2	5	01 222 106
2	5	01 222 107



COMPOSITE UNIONS – Plain/brass taper male BSP thread

Size (inch)	Standard pack quantity	Product Code
1/2	10	01 223 102
3/4	10	01 223 103
1	10	01 223 104
1 1/4	5	01 223 105
1 1/2	5	01 223 106
2	5	01 223 107



SS FEMALE COMPOSITE UNIONS – ABS/Stainless Steel 316L, BSP parallel female

Size (inch)	Standard pack quantity	Product Code
1/2	10	01 218 102
3/4	10	01 218 103
1	10	01 218 104
1 1/4	5	01 218 105
1 1/2	5	01 218 106
2	5	01 218 107



SS MALE COMPOSITE UNIONS – ABS/Stainless Steel 316L, BSP taper male

Size (inch)	Standard pack quantity	Product Code
1/2	10	01 219 102
3/4	10	01 219 103
1	10	01 219 104
1 1/4	5	01 219 105
1 1/2	5	01 219 106
2	5	01 219 107



SOCKETS – Female BSP thread

Size (inch)	Standard pack quantity	Product Code
1/2	10	01 102 102
3/4	10	01 102 103
1	10	01 102 104
1 1/4	10	01 102 105
1 1/2	10	01 102 106
2	5	01 102 107
3	1	01 102 109



REDUCING BUSHES – Male/female BSP thread

Size (inch)	Standard pack quantity	Product Code
1/2 x 3/8	10	01 113 121
3/4 x 1/2	10	01 113 122
1 x 3/4	10	01 113 124



ELBOWS 90° – Female BSP thread

Size (inch)	Standard pack quantity	Product Code
1/2	10	01 117 102
3/4	10	01 117 103
1	10	01 117 104
1 1/2	5	01 117 106
2	5	01 117 107



END CAPS – Female BSP thread

Size (inch)	Standard pack quantity	Product Code
1/2	10	01 141 102
1	10	01 141 103
1 1/4	10	01 141 104
1 1/2	10	01 141 105
2	10	01 141 106
2 1/2	5	01 141 107
3	1	01 141 109

SuperFlo ABS

Imperial solvent weld fittings



PLUGS – Male BSP thread

Size (inch)	Standard pack quantity	Product Code
1/2	10	01 155 102
3/4	10	01 155 103
1	10	01 155 104
1 1/4	10	01 155 105
1 1/2	10	01 155 106
2	10	01 155 107



HEXAGON NIPPLES – Male BSP thread

Size (inch)	Standard pack quantity	Product Code
1/2	10	01 106 102
3/4	10	01 106 103
1	10	01 106 104
1 1/4	10	01 106 105
1 1/2	5	01 106 106
2	5	01 106 107



FLANGES STUB – Plain/serrated

Size (inch)	Standard pack quantity	Product Code
2	5	01 135 107
2 1/2	5	11 135 312
3	1	01 135 109
4	1	01 135 110
5	1	11 135 316
6	1	01 135 112
8	1	01 135 113



BACK NUTS – Female BSP thread

Size (inch)	Standard pack quantity	Product Code
1/2	10	01 159 102
3/4	10	01 159 103
1	10	01 159 104
1 1/4	10	01 159 105
1 1/2	10	01 159 106
2	10	01 159 107
2 1/2	10	01 159 108
3	10	01 159 109
4	10	01 159 110



FULL FACE FLANGE – Undrilled

Size (inch)	Standard pack quantity	Product Code
Undrilled		
1/2	10	01 129 102
3/4	10	01 129 103
1	10	01 129 104
1 1/4	5	01 129 105
1 1/2	5	01 129 106
2	5	01 129 107
3	1	01 129 109
4	1	01 129 110
6	1	01 129 112

Note: It is essential that backing rings are used with all types of stub, full face and blanking flanges.



FULL FACE FLANGE – drilled

Size (inch)	Standard pack quantity	Product Code
Drilled to BS 10:1962 Table D/E		
1/2	10	01 130 102
3/4	10	01 130 103
1	10	01 130 104
1 1/4	5	01 130 105
1 1/2	5	01 130 106
2	5	01 130 107
3	1	01 130 109
4*	1	01 130 110
6	1	01 130 112
Drilled to BS EN1092-1, PN16 (Formerly BS 4504)**		
1/2	10	01 319 102
3/4	10	01 319 103
1	10	01 319 104
1 1/4	5	01 319 105
1 1/2	5	01 319 106
2	5	01 319 107
3	1	01 319 109
4	1	01 319 110
6	1	01 319 112

Drilled to ANSI Class 150		
1/2	10	01 322 102
3/4	10	01 322 103
1	10	01 322 104
1 1/2	5	01 130 106
2	5	01 322 107
3	1	01 322 109
4	1	01 322 110
6	1	01 322 112

*For table D drilling, use order code 01 317 110.
**Also matches PN10 drillings.



FULL FACE GASKETS – Drilled EPDM

410/408/426

Size (inch)	Standard pack quantity	Product Code
Drilled to BS 10:1962 Table D/E		
1/2	1	03 410 102
3/4	1	03 410 103
1	1	03 410 104
1 1/4	1	03 410 105
1 1/2	1	03 410 106
2	1	03 410 107
3	1	03 410 109
4*	1	03 410 110
6	1	03 410 112
Drilled to BS EN1092-1, PN16 (Formerly BS 4504) Section 3.1:1989 Tables 10 & 11		
1/2	1	03 408 102
3/4	1	03 408 103
1	1	03 408 104
1 1/4	1	03 408 105
1 1/2	1	03 408 106
2	1	03 408 107
3	1	03 408 109
4	1	03 408 110
6	1	03 408 112
Drilled to ANSI class 150		
1/2	1	03 426 102
3/4	1	03 426 103
1	1	03 426 104
1 1/2	1	03 426 106
2	1	03 426 107
3	1	03 426 109
4	1	03 426 110
6	1	03 426 112

Also matches PN10 drillings.

*Order Code 409 for Table D drilling.

SuperFlo ABS

Imperial accessories



BACKING RING – Galvanised Mild Steel

Size (inch)	Standard pack quantity	Product Code
Drilled to BS 10:1962 Table D/E		
1/2	1	03 416 102
3/4	1	03 416 103
1	1	03 416 104
1 1/4	1	03 416 105
1 1/2	1	03 416 106
2	1	03 416 107
3	1	03 416 109
4*	1	03 416 110
6	1	03 416 112
Drilled to BS EN1092-1, PN16 (Formerly BS 4504) Section 3.1:1989 Tables 10 & 11		
1/2	1	03 421 102
3/4	1	03 421 103
1	1	03 421 104
1 1/4	1	03 421 105
1 1/2	1	03 421 106
2	1	13 421 311
2 1/2	1	13 421 312
3	1	13 421 313
4	1	03 421 110
5	1	13 421 316
6**	1	03 421 112
8	1	03 421 113

*For table D drilling, use order code 03 415 110.
** 1/2" to 6" also matches PN10 drillings.



BACKING RING – Galvanised Mild Steel

Size (inch)	Standard pack quantity	Product Code
Drilled to BS EN1092-1, PN10 (Formerly BS 4504) Section 3.1:1989 Tables 10 & 11 *		
8**	1	03 404 113
Drilled to ANSI Class 150		
1/2	1	03 425 102
3/4	1	03 425 103
1	1	03 425 104
1 1/2	1	03 425 106
2	1	03 425 107
3	1	03 425 109
4	1	03 425 110
6	1	03 425 112
8	1	03 425 113

* The PN10 8" drilling has 8 holes (8" PN16 has 12 holes) and therefore is compatible with the FK 8" butterfly valve.
** Made to Order (Please refer to our Terms & Conditions)



BLANKING FLANGES – Undrilled

Size (inch)	Standard pack quantity	Product Code
Undrilled		
1	10	01 131 104
1 1/2	5	01 131 106
2	5	01 131 107
3	1	01 131 109
4	1	01 131 110
6	1	01 131 112
8	1	01 131 113

Note: It is essential that backing rings are used with all blanking flanges.



BLANKING FLANGES – Drilled

Size (inch)	Standard pack quantity	Product Code
Drilled to BS 10:1962 Table D/E		
2	5	01 313 107
3	1	01 313 109
4*	1	01 313 110
6	1	01 313 112
8	1	01 313 113
Drilled to BS EN1092-1, PN16 (Formerly BS 4504)		
2**	5	01 323 107
2 1/2	5	11 323 312
3	1	01 323 109
4	1	01 323 110
5	1	11 323 316
6**	1	01 323 112
8	1	01 323 113
Drilled to ANSI Class 150		
2	5	01 325 107
3	1	01 325 109
4	1	01 325 110
6	1	01 325 112
8	1	01 325 113

*For table D drilling, use order code 01 326 110
** Also matches PN10 drilling.



FLAT GASKET – EPDM, for use with stub flange

Size (inch)	Standard pack quantity	Product Code
2	1	03 431 107
2 1/2	1	13 411 312
3	1	03 431 109
4	1	03 431 110
5	1	13 411 316
6	1	03 431 112
8	1	03 431 113

For use with stub flanges 135/139.



VALVE SUPPORT PLATES – Galvanised mild steel, drilled

Size (inch)	Standard pack quantity	Product Code
Drilled to BS EN1029-1, PN10/PN16 (Formerly BS 4504)		
1/2*	1	03 458 102
3/4	1	03 458 103
1	1	03 458 104
1 1/4	1	03 458 105
1 1/2	1	03 458 106
2	1	03 458 107
2 1/2	1	31 459 312
3	1	03 458 109
4	1	03 458 110
6*	1	03 458 112
8	1	03 458 113

* Also matches PN10 drillings.

SuperFlo ABS

Imperial valves & accessories



O-RING SEALS - For use with socket unions

Size (inch)	Standard pack quantity	Product Code
EPDM for use with 205 series socket unions		
1/2	1	03 209 102
3/4	1	03 209 103
1	1	03 209 104
1 1/4	1	13 209 309
1 1/2	1	13 209 310
2	1	03 306 107
2 1/2	1	13 209 312
3	1	03 209 109
4	1	03 209 110
FKM for use with 204 series socket unions		
1/2	1	03 211 102
3/4	1	03 211 103
1	1	03 211 104
1 1/4	1	03 211 105
1 1/2	1	03 211 106
2	1	03 211 107
2 1/2	1	13 211 312
3	1	03 211 109
4	1	03 211 110



VKD DOUBLE UNION BALL VALVES MANUAL BS PLAIN FEMALE ENDS - EPDM seals

Size (inch)	Standard pack quantity	Product Code
1/2	1	H0 DKA 102
3/4	1	H0 DKA 103
1	1	H0 DKA 104
1 1/4	1	H0 DKA 105
1 1/2	1	H0 DKA 106
2	1	H0 DKA 107

Note: FKM seals available on request



LOCKABLE VKD DOUBLE UNION BALL VALVES MANUAL LOCKING HANDLE BS PLAIN FEMALE ENDS - EPDM seals

Size (inch)	Standard pack quantity	Product Code
1/2	1	H0 DLA 102
3/4	1	H0 DLA 103
1	1	H0 DLA 104
1 1/4	1	H0 DLA 105
1 1/2	1	H0 DLA 106
2	1	H0 DLA 107

Note: FKM seals available on request



TKD 3-WAY BALL VALVES L-PORT BS SERIES, PLAIN FEMALE ENDS - EPDM seals

Size (inch)	Standard pack quantity	Product Code
2 1/2	1	H0 DKA 312
3	1	H0 DKA 109
4	1	H0 DKA 110

Note: VKD ball valves are available with flanged ends (ISO-DIN) on request. Order via Code H0 DKA F**



TKD 3-WAY BALL VALVES T-PORT BS SERIES, PLAIN FEMALE ENDS - EPDM seals

Size (inch)	Standard pack quantity	Product Code
1/2	1	H0 TTA 102
3/4	1	H0 TTA 103
1	1	H0 TTA 104
1 1/4	1	H0 TTA 105
1 1/2	1	H0 TTA 106
2	1	H0 TTA 107

Lockable Handle Option available upon request: Please order Code reference 'TLA'



TKD 3-WAY BALL VALVES L-PORT BS SERIES, PLAIN FEMALE ENDS - EPDM seals

Size (inch)	Standard pack quantity	Product Code
1/2	1	H0 LTA 102
3/4	1	H0 LTA 103
1	1	H0 LTA 104
1 1/4	1	H0 LTA 105
1 1/2	1	H0 LTA 106
2	1	H0 LTA 107

Lockable Handle Option available upon request: Please order Code reference 'LLA'



VXE EASYFIT DOUBLE UNION BALL VALVES BS PLAIN FEMALE ENDS - EPDM seals

Size (inch)	Standard pack quantity	Product Code
1/2	1	H0 XEA 102
3/4	1	H0 XEA 103
1	1	H0 XEA 104
1 1/4	1	H0 XEA 105
1 1/2	1	H0 XEA 106
2	1	H0 XEA 107

Note: FKM seals available on request

SuperFlo ABS

Imperial valves & accessories



SET OF TRANSPARENT SERVICE PLUGS AND WHITE PVC TAG HOLDERS - For insertion in handle for VXE Easyfit valve customisation

Size (mm/inch)	Standard pack quantity	Product Code
16-20 / 1/2	20	LCE020
25/3/4	20	LCE025
32 / 1	20	LCE032
40 / 1 1/4	20	LCE040
50 / 1 1/2	20	LCE050
63 / 2	20	LCE063



DIE CUT LABELS PLUS SOFTWARE - White waterproof A4 sheets and freeware editing software to be used with inkjet printers for VXE Easyfit valve customisation

Size (mm/inch)	No. of sheets	Total labels	Product Code
16-20 / 1/2	10	500	LSE020
25/3/4	10	500	LSE025
32 / 1	10	500	LSE032
40 / 1 1/4	10	500	LSE040
50 / 1 1/2	10	400	LSE050
63 / 2	10	400	LSE063



VKR METERING BALL VALVES BS PLAIN FEMALE ENDS - EPDM seals

Size (inch)	Standard pack quantity	Product Code
3/8	1	H0 MBA 101
1/2	1	H0 MBA 102
3/4	1	H0 MBA 103
1	1	H0 MBA 104
1 1/4	1	H0 MBA 105
1 1/2	1	H0 MBA 106
2	1	H0 MBA 107

All VKD, TKD Ball valves are also available with FKM seals.



SX EASYFIT BALL CHECK VALVES BS PLAIN FEMALE ENDS - EPDM seals

Size (inch)	Standard pack quantity	Product Code
1/2	1	H0 SXA 102
3/4	1	H0 SXA 103
1	1	H0 SXA 104
1 1/4	1	H0 SXA 105
1 1/2	1	H0 SXA 106
2	1	H0 SXA 107

Note: FKM seals available on request



SX EASYFIT AIR RELEASE VALVES BS PLAIN FEMALE ENDS - EPDM seals

Size (inch)	Standard pack quantity	Product Code
1/2	1	H0 SAA 102
3/4	1	H0 SAA 103
1	1	H0 SAA 104
1 1/4	1	H0 SAA 105
1 1/2	1	H0 SAA 106
2	1	H0 SAA 107

Note: FKM seals available on request



UV Y-TYPE STRAINERS PLAIN FEMALE ENDS - EPDM seals

Size (inch)	Standard pack quantity	Product Code
1/2	1	H0 UVA 102
3/4	1	H0 UVA 103
1	1	H0 UVA 104
1 1/4	1	H0 UVA 105
1 1/2	1	H0 UVA 106
2	1	H0 UVA 107

Note: FKM seals available on request



DIALOCK® DIAPHRAGM VALVES MANUAL - plain female ends - EPDM seals

Size (inch)	Standard pack quantity	Product Code
1/2	1	H0 DVA 102
3/4	1	H0 DVA 103
1	1	H0 DVA 104
1 1/4	1	H0 DVA 105
1 1/2	1	H0 DVA 106
2	1	H0 DVA 107

Larger sizes available upon request. Minimum order quantities apply.

FKM or PTFE seal options available on request.



LR PRESSURE LOADING/RELIEF VALVES PLAIN FEMALE ENDS - EPDM Seals

Size (inch)	Standard pack quantity	Product Code
1/2	1	H0 LRA 102
3/4	1	H0 LRA 103
1	1	H0 LRA 104
1 1/4	1	H0 LRA 105
1 1/2	1	H0 LRA 106
2	1	H0 LRA 107

FKM or PTFE seal options available on request.

SuperFlo ABS

Imperial valves & accessories



FK BUTTERFLY VALVE – With Lever Handle – EPDM Seals

Size (inch)	Standard pack quantity	Product Code
1 1/2	1	HO FKA 106
2	1	HO FKA 107
2 1/2	1	HO FKA 108
3	1	HO FKA 109
4	1	HO FKA 110
5	1	HO FKA 111
6	1	HO FKA 112
8	1	HO FKA 113

FK Butterfly valves are also available with FKM seals, please ask for details.s.



FK BUTTERFLY VALVES – With gear box – EPDM Seals

Size (inch)	Standard pack quantity	Product Code
2 1/2	1	HV FKA 108
3	1	HV FKA 109
4	1	HV FKA 110
5	1	HV FKA 111
6	1	HV FKA 112
8	1	HV FKA 113
10	1	HV FKA 114
12	1	HV FKA 115

FK Butterfly valves are also available with FKM seals, please ask for details.



SADDLE CLIPS – Polypropylene

Size (inch)	Standard pack quantity	Product Code
16 3/8	10	03 455 101
20 1/2	10	03 455 102
25 3/4	10	03 455 103
32/1	10	03 455 104
40/1 1/4	10	03 455 105
50/1 1/2	10	03 455 106
63/2	10	03 455 107
16/3	10	03 455 109
110/4	10	03 455 110



COBRA PIPE CLIPS

Size (inch)	Standard pack quantity	Product Code
*12	10	13 434 304
*16 3/8	10	13 434 305
*20 1/2	10	13 434 306
*25 3/4	10	13 434 307
32/1	10	13 434 308
40/1 1/4	10	13 434 309
50/1 1/2	10	13 434 310
63/2	10	13 434 311
75/2 1/2	10	13 434 312
90/3	10	13 434 313
110/4	10	13 434 314
125	10	13 434 315
140/5	10	13 434 316
160/6	10	13 434 317

*Without retaining clips. Bolts/screws not supplied.



CHAMFERING AND DE-BURRING TOOLS

Description	Product Code
16-63mm pipe chamfering tool	FT 55 65 12
75-160mm chamfering tool	FT 55 05 10



PIPE CUTTERS

Description	Product Code
16-63mm pipe cutter	FT 80 00 01
50-125mm pipe cutter	FT 80 00 03
16-63mm spare cutter wheel	FT 80 00 02
50-125mm spare cutter wheel	FT 80 00 04



SUPERFLO ONE-STEP SOLVENT CEMENT AND ECO-CLEANER

Description	Standard pack quantity in units	Product Code
500ml SuperFLO grey one-step cement	12	03 461 395
1 litre SuperFLO grey one-step cement	6	03 461 396



KOLMAT FIBRESEAL – For threaded connections

Description	Product Code
FibreSeal tape	03 469 395



SILICONE REPAIR TAPE

Description	Product Code
Silicone Repair Tape	03 469 400

Why choose plastic pipe systems?

Plastic pipes have been at the centre of the clean water revolution since their introduction in the mid-20th century.

Ever since, significant benefits over traditional materials have been realised, and the popularity of plastic pipe systems have grown rapidly.

Plastic pipes are not only an excellent choice for transporting water, their characteristics are also ideal for a wide range of industrial applications.



Lightweight, easy to install



Reduced biofilm build-up



Lowers the risk of theft



Faster installation



Corrosion resistant



Cost effective



No hot-works required



A sustainable solution



Durapipe PVC



Durapipe PVC

Imperial system



PREMIUM PIPE - PVC-U Class C 511

Pipe Diameter (inch)	Standard length in metres	Product Code
2	6	06 511 107
3	6	06 511 109
4	6	06 511 110
5	6	06 511 111
6	6	06 511 112
8	6	06 511 113

Reg 31 & WRAS approved



PREMIUM PIPE - PVC-U Class D 512

Pipe Diameter (inch)	Standard length in metres	Product Code
1¼	6	06 512 105
1½	6	06 512 106
2	6	06 512 107
3	6	06 512 109
4	6	06 512 110
5	6	06 512 111
6	6	06 512 112
8	6	06 512 113

Reg 31 & WRAS approved



PREMIUM PIPE - PVC-U Class E 513

Pipe Diameter (inch)	Standard length in metres	Product Code
½	6	06 513 102
¾	6	06 513 103
1	6	06 513 104
1¼	6	06 513 105
1½	6	06 513 106
2	6	06 513 107
3	6	06 513 109
4	6	06 513 110
6	6	06 513 112

Reg 31 & WRAS approved



PREMIUM PIPE - PVC-U CLASS 7 514

Pipe Diameter (inch)	Standard length in metres	Product Code
½	6	06 514 102
¾	6	06 514 103
1	6	06 514 104
1¼	6	06 514 105
1½	6	06 514 106
2	6	06 514 107

Reg 31 & WRAS approved



OPTIMA PIPE PVC-U CLASS C 515

Pipe Diameter (inch)	Standard length in metres	Product Code
2	6	06 515 107
3	6	06 515 109
4	6	06 515 110
5	6	06 515 111
6	6	06 515 112

WRAS approved



OPTIMA PIPE PVC-U CLASS E 516

Pipe Diameter (inch)	Standard length in metres	Product Code
½	6	06 516 102
¾	6	06 516 103
1	6	06 516 104
1¼	6	06 516 105
1½	6	06 516 106
2	6	06 516 107
3	6	06 516 109
4	6	06 516 110
6	6	06 516 112
10	6	06 516 114
12	6	06 516 115

10" and 12" product is supplied as Sch80 standard pipe

WRAS approved



CLEAR PIPE PVC-U 517

Pipe Diameter (inch)	Standard length in metres	Product Code
½	3	06 517 102
¾	3	06 517 103
1	3	06 517 104
1¼	3	06 517 105
1½	3	06 517 106
2	3	06 517 107
3	3	06 517 109
4	3	06 517 110
6	3	06 517 112
8	3	06 517 113

½" up to 1½" - Class E
2" up to 4" - Class D
6" up to 8" - Class C

WRAS approved

Durapipe PVC

Imperial system



SOCKETS (MLV) PLAIN 100

Size (inch)	Standard pack quantity	Product Code
½	10	02 100 102
¾	10	02 100 103
1	10	02 100 104
1¼	10	02 100 105
1½	10	02 100 106
2	10	02 100 107
2½	5	33 100 312
3	1	02 100 109
4	1	02 100 110
5	1	33 100 316
6	1	02 100 112
8	1	02 100 113
10*	1	02 100 114
12*	1	02 100 115

* Made to Order (Please refer to our Terms & Conditions).



REDUCING BUSHES (DLV) - Plain

109 329

Size (inch)	Standard pack quantity	Product Code
¾ x ½	10	02 109 122
1 x ½	10	02 109 123
1 x ¾	10	02 109 124
1¼ x 1	10	02 109 125
1½ x ¾	10	02 109 119
1½ x 1	10	02 109 126
1½ x 1¼	10	02 109 127
2 x 1	10	02 109 128
2 x 1¼	10	02 109 129
2 x 1½	10	02 109 130
2½ x 2	5	02 109 131
3 x 1½	5	02 109 134
3 x 2	5	02 109 135
3 x 2½	5	02 109 136
4 x 2	1	02 109 140
4 x 3	1	02 109 141
5 x 4	1	02 329 142
6 x 4	1	02 109 147
8 x 6	1	02 109 152
10 x 8*	1	02 109 151
12 x 10*	1	02 109 153

* Made to Order (Please refer to our Terms & Conditions).



ELBOWS (MLV) - Plain 119

Size (inch)	Standard pack quantity	Product Code
½	10	02 119 102
¾	10	02 119 103
1	10	02 119 104
1¼	10	02 119 105
1½	10	02 119 106
2	5	02 119 107
2½	1	33 119 312
3	1	02 119 109
4	1	02 119 110
5	1	33 119 316
6	1	02 119 112
8	1	02 119 113
10*	1	02 119 114
12*	1	02 119 115

* Made to Order (Please refer to our Terms & Conditions).



ELBOWS 90° (GLV) - Plain 115

Size (inch)	Standard pack quantity	Product Code
½	10	02 115 102
¾	10	02 115 103
1	10	02 115 104
1¼	10	02 115 105
1½	10	02 115 106
2	5	02 115 107
2½	1	33 115 312
3	1	02 115 109
4	1	02 115 110
5	1	33 115 316
6	1	02 115 112
8	1	02 115 113
10*	1	02 115 114
12*	1	02 115 115

* Made to Order (Please refer to our Terms & Conditions).

Durapipe PVC

Imperial system



TEES 90° EQUAL (TLV) - Plain 122

Size (inch)	Standard pack quantity	Product Code
1/2	10	02 122 102
3/4	10	02 122 103
1	10	02 122 104
1 1/4	10	02 122 105
1 1/2	5	02 122 106
2	5	02 122 107
2 1/2	1	33 122 312
3	1	02 122 109
4	1	02 122 110
5	1	33 122 316
6	1	02 122 112
8	1	02 122 113
10*	1	02 122 114
12*	1	02 122 115

* Made to Order (Please refer to our Terms & Conditions).



BENDS 22 1/2° LONG RADIUS 311

Size (inch)	Standard pack quantity	Product Code
1*	1	02 311 104
1 1/2*	1	02 311 106
2*	1	02 311 107
3*	1	02 311 109
4*	1	02 311 110
6*	1	02 311 112

* Made to Order (Please refer to our Terms & Conditions).

Note: Special angled bends can be supplied by order: Angles between 0° and 90° - POA.



BENDS 45° LONG RADIUS 310

Size (inch)	Standard pack quantity	Product Code
1*	1	02 310 104
1 1/2*	1	02 310 106
2*	1	02 310 107
3*	1	02 310 109
4*	1	02 310 110
6*	1	02 310 112

* Made to Order (Please refer to our Terms & Conditions).



BENDS 90° LONG RADIUS 309

Size (inch)	Standard pack quantity	Product Code
3*	1	02 309 109
4*	1	02 309 110
6*	1	02 309 112

* Made to Order (Please refer to our Terms & Conditions).



BENDS 90° (SLV) - Short radius 118

Size (inch)	Standard pack quantity	Product Code
1/2	10	02 118 102
3/4	10	02 118 103
1	10	02 118 104
1 1/4	5	02 118 105
1 1/2	1	02 118 106
2	1	02 118 107
2 1/2	1	33 118 312
3	1	02 118 109
4	1	02 118 110



END CAPS (CLV) - Plain 140

Size (inch)	Standard pack quantity	Product Code
1/2	10	02 140 102
3/4	10	02 140 103
1	10	02 140 104
1 1/4	10	02 140 105
1 1/2	10	02 140 106
2	5	02 140 107
2 1/2	5	33 140 312
3	5	02 140 109
4	1	02 140 110



SOCKET UNIONS (BLV) - Plain - EPDM 205

Size (inch)	Standard pack quantity	Product Code
1/2	10	02 205 102
3/4	10	02 205 103
1	10	02 205 104
1 1/4	5	02 205 105
1 1/2	5	02 205 106
2	5	02 205 107
2 1/2	1	33 205 312
3	1	02 205 109
4	1	02 205 110

3" and 4" are Class C rated. EPDM seal as standard.



SOCKET UNIONS (BLV) - Plain - FKM 204

Size (inch)	Standard pack quantity	Product Code
1/2	10	02 204 102
3/4	10	02 204 103
1	10	02 204 104
1 1/4	5	02 204 105
1 1/2	5	02 204 106
2	5	02 204 107
2 1/2	1	33 204 312
3	1	02 204 109
4	1	02 204 110

Durapipe PVC

Imperial system



IMPERIAL/METRIC SOCKET ADAPTORS (MILV) - Plain 345

Size (inch/mm)	Standard pack quantity	Product Code
1/2 x 20	10	33 345 102
3/4 x 25	10	33 345 103
1 x 32	10	33 345 104
1 1/4 x 40	10	33 345 105
1 1/2 x 50	10	33 345 106
2 x 63	5	33 345 107
2 1/2 x 75	1	33 100 312
3 x 90	1	33 345 109
4 x 110	1	33 345 110



SOCKETS (MLFV) - Plain/female BSP thread 101

Size (inch)	Standard pack quantity	Product Code
1/2	10	02 101 102
3/4	10	02 101 103
1	10	02 101 104
1 1/4	10	02 101 105
1 1/2	10	02 101 106
2	5	02 101 107
2 1/2	1	33 101 108
3	1	02 101 109
4	1	02 101 110



ELBOWS 90° (GLFV) - Plain/female BSP thread 116

Size (inch)	Standard pack quantity	Product Code
1/2	10	02 116 102
3/4	10	02 116 103
1	10	02 116 104
1 1/4	10	02 116 105
1 1/2	5	02 116 106
2	5	02 116 107
2 1/2	5	33 116 108
3	5	02 116 109
4	5	02 116 110



TEES 90° EQUAL (TLFV) - Plain/female threaded branch 123

Size (inch)	Standard pack quantity	Product Code
1/2	10	02 123 102
3/4	10	02 123 103
1	10	02 123 104
1 1/4	5	02 123 105
1 1/2	5	02 123 106
2	5	02 123 107
2 1/2	1	02 123 108
3	1	02 123 109



REDUCING BUSHES - Plain spigot/female BSP thread 111

Size (inch/mm)	Standard pack quantity	Product Code
1/2 x 3/8	10	02 111 121
3/4 x 1/2	10	02 111 122
1 x 3/4	10	02 111 124



MALE THREADED ADAPTORS (ILFV) - Plain/male BSP thread 151

Size (inch)	Standard pack quantity	Product Code
1/2	10	02 151 102
3/4	10	02 151 103
1	10	02 151 104
1 1/4	10	02 151 105
1 1/2	5	02 151 106
2	5	02 151 107



FEMALE THREADED ADAPTORS (ILFV) - Plain/male BSP thread 153

Size (inch)	Standard pack quantity	Product Code
1/2	10	02 153 102
3/4	10	02 153 103
1	10	02 153 104
1 1/4	10	02 153 105
1 1/2	5	02 153 106
2	5	02 153 107



BARREL NIPPLES - Plain/male BSP thread 316

Size (inch)	Standard pack quantity	Product Code
1/2	10	02 316 102
3/4	10	02 316 103
1	10	02 316 104
1 1/4	10	02 316 105
1 1/2	5	02 316 106
2	5	02 316 107
3	5	02 316 109
4	5	02 316 110

Durapipe PVC

Imperial system



HOSE ADAPTORS (AFV) - Male BSP thread/hose tail 157

Size (inch/mm)	Standard pack quantity	Product Code
Male BSP thread/hose tail - short pattern		
1/2	10	02 157 102
3/4	10	02 157 103
1	10	02 157 104
Male BSP thread/hose tail - long pattern		
1/4 x 12 x 14	10	02 157 600
3/8 x 16 x 18	10	02 157 602
1/2 x 20 x 22	10	02 157 605
3/4 x 25 x 27	10	02 157 608
1 x 30 x 32	10	02 157 612
1 1/4 x 40 x 42	5	02 157 616
1 1/2 x 50 x 52	5	02 157 622
2 x 60 x 64	5	02 157 629



HOSE ADAPTORS - Female BSP thread/hose tail - loose nut 156

Size (inch/mm)	Standard pack quantity	Product Code
Female BSP thread/hose tail		
1/2 x 12 x 14	10	02 156 601
3/4 x 16 x 18	10	02 156 603
1 x 20 x 22	10	02 156 606
1 1/4 x 25 x 27	10	02 156 609
1 1/2 x 30 x 32	10	02 156 613
2 x 40 x 42	5	02 156 616
2 1/4 x 50 x 52	5	02 156 623
2 1/2 x 60 x 64	5	02 156 312
2 3/4 x 60 x 64	5	02 156 630



TANK CONNECTORS - Plain/male BSP thread EPDM gasket 235

Size (inch)	Standard pack quantity	Product Code
1/2	10	02 235 102
3/4	10	02 235 103
1	10	02 235 104
1 1/4	10	02 235 105
1 1/2	10	02 235 106
2	10	02 235 107
2 1/2	10	02 235 108
3	10	02 235 109
4	10	02 235 110



COMPOSITE UNIONS - Plain/brass female BSP parallel thread 222

Size (inch)	Standard pack quantity	Product Code
1/2	10	02 222 102
3/4	10	02 222 103
1	10	02 222 104
1 1/4	5	02 222 105
1 1/2	5	02 222 106
2	5	02 222 107



COMPOSITE UNIONS - Plain/brass male BSP taper thread 223

Size (inch)	Standard pack quantity	Product Code
1/2	10	02 223 102
3/4	10	02 223 103
1	10	02 223 104
1 1/4	5	02 223 105
1 1/2	5	02 223 106
2	5	02 223 107



SS FEMALE COMPOSITE UNIONS - PVC/Stainless Steel 316L, BSP female parallel thread 218

Size (inch)	Standard pack quantity	Product Code
1/2	10	02 218 102
3/4	10	02 218 103
1	10	02 218 104
1 1/4	5	02 218 105
1 1/2	5	02 218 106
2	5	02 218 107



SS MALE COMPOSITE UNIONS - Plain/Stainless Steel 316L, BSP male taper thread 219

Size (inch)	Standard pack quantity	Product Code
1/2	10	02 219 102
3/4	10	02 219 103
1	10	02 219 104
1 1/4	5	02 219 105
1 1/2	5	02 219 106
2	5	02 219 107



SOCKETS - Female BSP thread 102

Size (inch)	Standard pack quantity	Product Code
1/2	10	02 102 102
3/4	10	02 102 103
1	10	02 102 104
1 1/4	10	02 102 105
1 1/2	10	02 102 106
2	5	02 102 107
2 1/2	5	02 102 108
3	1	02 102 109



SOCKET UNIONS - Plain/BSP thread 202

Size (inch)	Standard pack quantity	Product Code
1/2*	10	02 202 102
3/4*	10	02 202 103
1*	10	02 202 104
1 1/4*	5	02 202 105
1 1/2*	5	02 202 106
2*	5	02 202 107

* Made to Order (Please refer to our Terms & Conditions).



REDUCING BUSHES - Male/female BSP thread 113

Size (inch/mm)	Standard pack quantity	Product Code
1/2 x 3/8	10	02 113 121
3/4 x 1/2	10	02 113 122
1 x 3/4	10	02 113 124
1 1/4 x 1	10	02 113 125
1 1/2 x 1 1/4	10	02 113 127
2 x 1 1/2	5	02 113 130



REDUCERS - Reduced female BSP thread/male BSP thread 173

Size (inch/mm)	Standard pack quantity	Product Code
1/2 x 3/8	10	02 173 121
3/4 x 3/8	10	02 173 164
3/4 x 1/2	10	02 173 122
1 x 3/8	10	02 173 166
1 x 1/2	10	02 173 123
1 x 3/4	10	02 173 124
1 1/4 x 1/2	10	02 173 116
1 1/4 x 3/4	10	02 173 117
1 1/4 x 1	10	02 173 125
1 1/2 x 1/2	10	02 173 118
1 1/2 x 3/4	10	02 173 119
1 1/2 x 1	10	02 173 126
1 1/2 x 1 1/4	10	02 173 127
2 x 3/4	2	02 173 120
2 x 1	2	02 173 128
2 x 1 1/4	2	02 173 129
2 x 1 1/2	2	02 173 130
2 1/2 x 2*	2	02 173 131
3 x 2*	2	02 173 135
3 x 2 1/2*	2	02 173 136
4 x 2*	2	02 173 140
4 x 2 1/2*	2	02 173 169
4 x 3*	2	02 173 141

* FIG B product image supplied



REDUCERS - Female BSP thread/reduced male BSP thread 174

Size (inch/mm)	Standard pack quantity	Product Code
3/4 x 1/2	10	02 174 122
1 x 1/2	10	02 174 123
1 x 3/4	10	02 174 124
1 1/4 x 1	10	02 174 125
1 1/2 x 1 1/4	10	02 174 127
2 x 1 1/2	2	02 174 130
2 1/2 x 2	2	02 174 131
3 x 2 1/2	2	02 174 136
4 x 3	1	02 174 141



ELBOWS 45° - Female BSP thread 120

Size (inch)	Standard pack quantity	Product Code
1/2	10	02 120 102
3/4	10	02 120 103
1	10	02 120 104
1 1/4	5	02 120 105
1 1/2	5	02 120 106
2	5	02 120 107
2 1/2	2	02 120 108
3	1	02 120 109



ELBOWS 90° - Female BSP thread 117

Size (inch)	Standard pack quantity	Product Code
1/2	10	02 117 102
3/4	10	02 117 103
1	10	02 117 104
1 1/4	10	02 117 105
1 1/2	5	02 117 106
2	5	02 117 107
2 1/2	2	02 117 108
3	1	02 117 109
4	1	02 117 110



ELBOWS 90° - Female BSP thread 117

Size (inch)	Standard pack quantity	Product Code
1/2	10	02 125 102
3/4	10	02 125 103
1	10	02 125 104
1 1/4	10	02 125 105
1 1/2	10	02 125 106
2	5	02 125 107
3	1	02 125 109
4	1	02 125 110

Durapipe PVC

Imperial system



END CAPS - Female BSP thread 141

Size (inch)	Standard pack quantity	Product Code
1/2	10	02 141 102
3/4	10	02 141 103
1	10	02 141 104
1 1/4	10	02 141 105
1 1/2	10	02 141 106
2	5	02 141 107
3	1	02 141 109
4	1	02 141 110



PLUGS - Male BSP thread 155

Size (inch)	Standard pack quantity	Product Code
1/2	10	02 155 102
3/4	10	02 155 103
1	10	02 155 104
1 1/4	10	02 155 105
1 1/2	10	02 155 106
2	10	02 155 107
3	1	02 155 109
4	1	02 155 110



HEXAGON NIPPLES - Male BSP thread 106

Size (inch)	Standard pack quantity	Product Code
1/2	10	02 106 102
3/4	10	02 106 103
1	10	02 106 104
1 1/4	10	02 106 105
1 1/2	5	02 106 106
2	5	02 106 107
2 1/2	2	02 106 108
3	1	02 106 109
4	1	02 106 110



BACK NUTS - Female BSP thread 159

Size (inch)	Standard pack quantity	Product Code
1/2	10	02 159 102
3/4	10	02 159 103
1	10	02 159 104
1 1/4	10	02 159 105
1 1/2	10	02 159 106
2	10	02 159 107
2 1/2	1	02 159 108
3	1	02 159 109
4	1	02 159 110



SOCKET UNIONS - Female BSP thread 203

Size (inch)	Standard pack quantity	Product Code
1/2	10	02 203 102
3/4	10	02 203 103
1	10	02 203 104
1 1/4	10	02 203 105
1 1/2	10	02 203 106
2	5	02 203 107

EPDM seal as standard. For FKM seal order by type 210.



CLEAR PVC-U STATIC MIXER (EPDM)

Size (inch)	Number of mixing elements	Product Code
1/2	6	SMC 6E 102
1/2	12	SMC 12E 102
3/4	6	SMC 6E 103
3/4	12	SMC 12E 103
1	6	SMC 6E 104
1	12	SMC 12E 104
1 1/4	6	SMC 6E 105
1 1/4	12	SMC 12E 105
1 1/2	6	SMC 6E 106
1 1/2	12	SMC 12E 106
2	6	SMC 6E 107
2	12	SMC 12E 107

FKM seals available on request.



FLANGES STUB - Plain/serrated face 135/139

Size (inch)	Standard pack quantity	Product Code
1/2	10	02 135 102
3/4	10	02 135 103
1	10	02 135 104
1 1/4	10	02 135 105
1 1/2	10	02 135 106
2	5	02 135 107
2 1/2	5	33 135 312
3	1	02 135 109
4	1	02 135 110
5	1	33 135 316
6	1	02 135 112
8	1	02 135 113
10*	1	02 139 114
12*	1	02 139 115

* Made to Order (Please refer to our Terms & Conditions).



FLANGES FULL FACE - Drilled 130/319/322

Size (inch)	Standard pack quantity	Product Code
Drilled to BS 10:1962 Table D/E		
1/2	10	02 130 102
3/4	10	02 130 103
1	10	02 130 104
1 1/4	5	02 130 105
1 1/2	5	02 130 106
2	1	02 130 107
3	1	02 130 109
4	1	02 130 110
Drilled to BS EN1092-1, PN16 (Formerly BS 4504) Section 3.1:1989 table 10 & 11		
1/2	10	02 319 102
3/4	10	02 319 103
1	10	02 319 104
1 1/4	5	02 319 105
1 1/2	5	02 319 106
2	1	02 319 107
3	1	02 319 109
4	1	02 319 110

Also matches PN10 drillings.



FLANGES BLANKING - Drilled 313/323/325

Size (inch)	Standard pack quantity	Product Code
Drilled to BS 10:1962 Table D/E		
2	5	02 313 107
3	1	02 313 109
4*	1	02 313 110
6	1	02 313 112
Drilled to BS EN1029-1, PN16 (Formerly BS 4504)		
1/2	1	02 323 102
3/4	1	02 323 103
1	1	02 323 104
1 1/2	1	02 323 106
2	5	02 323 107
3	1	02 323 109
4	1	02 323 110
6	1	02 323 112

*Order Code 326 for Table D drilling.

2" to 6" also matches PN10 drillings.



FLANGES BLANKING - Plain 131

Size (inch)	Standard pack quantity	Product Code
1/2*	1	02 131 102
3/4*	1	02 131 103
1*	1	02 131 104
1 1/2*	1	02 131 106
2*	1	02 131 107
3*	1	02 131 109
4*	1	02 131 110
6*	1	02 131 112

* Made to Order (Please refer to our Terms & Conditions).

Note: It is essential that backing rings are used with all types of stub, full face and blanking flanges. Blanking flanges to BS10 have outside diameters to that standard.



BACKING RINGS - Galvanised mild steel, drilled 416/407/403/421/425

Size (inch)	Standard pack quantity	Product Code
Drilled to BS 10:1962 Table D/E		
1/2	1	03 416 102
3/4	1	03 416 103
1	1	03 416 104
1 1/4	1	03 416 105
1 1/2	1	03 416 106
2	1	03 416 107
3	1	03 416 109
4*	1	03 416 110
6	1	03 416 112
8	1	03 416 113
10	1	03 416 114

*Order Code 415 for Table D drilling.

Size (inch)	Standard pack quantity	Product Code
Drilled to BS EN1092-1, PN10/PN16 (Formerly BS 4504)		
1/2	1	13 421 306
3/4	1	13 421 307
1	1	13 421 308
1 1/4	1	13 421 309
1 1/2	1	13 421 310
2	1	13 421 311
2 1/2	1	13 421 312
3	1	13 421 313
4	1	13 421 314
5	1	13 421 316
Drilled to BS EN1092-1, PN10 (Formerly BS 4504)		
8	1	13 421 319
10	1	13 421 321
12	1	13 421 323
Drilled to BS EN1092-1, PN16 (Formerly BS 4504)		
8	1	13 420 319
10*	1	03 403 114
12*	1	13 420 323
Drilled to ANSI Class 150		
1/2	1	13 448 306
3/4	1	13 448 307
1	1	13 448 308
1 1/4	1	13 448 309
1 1/2	1	13 448 310
2	1	13 448 311
2 1/2	1	13 448 312
3	1	13 448 313
4	1	13 448 314
5	1	13 448 315
6	1	13 448 316
7	1	13 448 317
8	1	13 448 318
10	1	13 448 319

* Made to Order (Please refer to our Terms & Conditions).

Note: PP/FRP backing rings are suitable for use with our PVC-U Imperial system, details can be found on page Xxx.

Durapipe PVC

Imperial system



BACKING RINGS - PVC-U - suitable for use with stub flanges 180

Size (inch)	Standard pack quantity	Product Code
Drilled to BS EN1092-1, PN10/PN16 (Formerly BS 4504)		
1/2	2	33 180 306
3/4	2	33 180 307
1	2	33 180 308
1 1/4	2	33 180 309
1 1/2	2	33 180 310
2	2	33 180 311
2 1/2	2	33 180 312
3	2	33 180 313
4	1	33 180 314
5	1	33 180 316
6	1	33 180 317
Drilled to BS EN1092-1, PN10 (Formerly BS 4504)		
8	1	33 180 319
10	1	33 180 320
12	1	33 180 323



GASKETS FLAT - EPDM, for use with stub flange 411/431

Size (inch)	Standard pack quantity	Product Code
2	1	03 431 107
2 1/2	1	13 411 312
3	1	03 431 109
4	1	03 431 110
5	1	13 411 316
6	1	03 431 112
8	1	03 431 113
10	1	03 411 114
12	1	03 411 115

For use with stub flanges (135/139).



GASKETS FULL FACE - Drilled EPDM 410/408/426

Size (inch)	Standard pack quantity	Product Code
Drilled to BS 10:1962 Table D/E		
1/2	1	03 410 102
3/4	1	03 410 103
1	1	03 410 104
1 1/4	1	03 410 105
1 1/2	1	03 410 106
2	1	03 410 107
3	1	03 410 109
4*	1	03 410 110
6	1	03 410 112
Drilled to BS EN1092-1, PN16 (Formerly BS 4504) Section 3.1:1989 table 10 & 11		
1/2	1	03 408 102
3/4	1	03 408 103
1	1	03 408 104
1 1/4	1	03 408 105
1 1/2	1	03 408 106
2	1	03 408 107
3	1	03 408 109
4	1	03 408 110
6	1	03 408 112
Drilled to ANSI class 150		
1/2	1	03 426 102
3/4	1	03 426 103
1	1	03 426 104
1 1/2	1	03 426 106
2	1	03 426 107
3	1	03 426 109
4	1	03 426 110
6	1	03 426 112

Also matches PN10 drillings.

*Order Code 409 for Table D drilling.



VALVE SUPPORT PLATES - Galvanised mild steel, drilled 458/459

Size (inch)	Standard pack quantity	Product Code
Drilled to BS EN1029-1, PN10/PN16 (Formerly BS 4504)		
1/2	1	03 458 102
3/4	1	03 458 103
1	1	03 458 104
1 1/4	1	03 458 105
1 1/2	1	03 458 106
2	1	03 458 107
2 1/2	1	31 459 312
3	1	03 458 109
4	1	03 458 110
6	1	03 458 112
8	1	03 458 113

1/2" to 6" also matches PN10 drillings.

Durapipe PVC

Valves - Imperial



VKD DOUBLE UNION BALL VALVES MANUAL - EPDM seals

Size (inch)	Standard pack quantity	Product Code
1/2	1	HO DKE 102
3/4	1	HO DKE 103
1	1	HO DKE 104
1 1/4	1	HO DKE 105
1 1/2	1	HO DKE 106
2	1	HO DKE 107



VKD DOUBLE UNION BALL VALVES MANUAL LOCKING HANDLE - EPDM seals

Size (inch)	Standard pack quantity	Product Code
1/2	1	HO DLE 102
3/4	1	HO DLE 103
1	1	HO DLE 104
1 1/4	1	HO DLE 105
1 1/2	1	HO DLE 106
2	1	HO DLE 107



VKD DOUBLE UNION BALL VALVES MANUAL - FKM seals

Size (inch)	Standard pack quantity	Product Code
1/2	1	HO DKF 102
3/4	1	HO DKF 103
1	1	HO DKF 104
1 1/4	1	HO DKF 105
1 1/2	1	HO DKF 106
2	1	HO DKF 107



VKD DOUBLE UNION BALL VALVES MANUAL LOCKING HANDLE - FKM seals

Size (inch)	Standard pack quantity	Product Code
1/2	1	HO DLF 102
3/4	1	HO DLF 103
1	1	HO DLF 104
1 1/4	1	HO DLF 105
1 1/2	1	HO DLF 106
2	1	HO DLF 107



VKD DOUBLE UNION BALL VALVES MANUAL - BSP threaded - EPDM seals

Size (inch)	Standard pack quantity	Product Code
1/2	1	HO DKE B02
3/4	1	HO DKE B03
1	1	HO DKE B04
1 1/4	1	HO DKE B05
1 1/2	1	HO DKE B06
2	1	HO DKE B07



VKD DOUBLE UNION BALL VALVES MANUAL LOCKING HANDLE - BSP threaded - EPDM seals

Size (inch)	Standard pack quantity	Product Code
1/2	1	HO DLE B02
3/4	1	HO DLE B03
1	1	HO DLE B04
1 1/4	1	HO DLE B05
1 1/2	1	HO DLE B06
2	1	HO DLE B07



VKD DOUBLE UNION BALL VALVES MANUAL - EPDM seals

Size (inch)	Standard pack quantity	Product Code
2 1/2	1	HO DKE 312
3	1	HO DKE 109
4	1	HO DKE 110

Lockable handle as standard



VKD DOUBLE UNION BALL VALVES MANUAL - BSP threaded - FKM seals

Size (inch)	Standard pack quantity	Product Code
1/2	1	HO DKF B02
3/4	1	HO DKF B03
1	1	HO DKF B04
1 1/4	1	HO DKF B05
1 1/2	1	HO DKF B06
2	1	HO DKF B07



VKD DOUBLE UNION BALL VALVES MANUAL - FKM seals

Size (inch)	Standard pack quantity	Product Code
2 1/2	1	HO DKF 312
3	1	HO DKF 109
4	1	HO DKF 110



VKD DOUBLE UNION BALL VALVES MANUAL - BSP threaded EPDM seals

Size (inch)	Standard pack quantity	Product Code
2 1/2	1	HO DKE B08
3	1	HO DKE B09
4	1	HO DKE B10

Durapipe PVC

Valves – Imperial



VXE EASYFIT DOUBLE UNION BALL VALVES - Manual - EPDM seals

Size (inch)	Standard pack quantity	Product Code
1/2	1	HO XEE 102
3/4	1	HO XEE 103
1	1	HO XEE 104
1 1/4	1	HO XEE 105
1 1/2	1	HO XEE 106
2	1	HO XEE 107
2 1/2	1	HO XEE 312
3	1	HO XEE 109
4	1	HO XEE 110

*FIG B product supplied.



VXE EASYFIT DOUBLE UNION BALL VALVES - Manual - FKM seals

Size (inch)	Standard pack quantity	Product Code
1/2	1	HO XEF 102
3/4	1	HO XEF 103
1	1	HO XEF 104
1 1/4	1	HO XEF 105
1 1/2	1	HO XEF 106
2	1	HO XEF 107
2 1/2	1	HO XEF 312
3	1	HO XEF 109
4	1	HO XEF 110

*FIG B product supplied.



VXE EASYFIT DOUBLE UNION BALL VALVES - Manual BSP threaded - EPDM seals

Size (inch)	Standard pack quantity	Product Code
1/2	1	HO XEE B02
3/4	1	HO XEE B03
1	1	HO XEE B04
1 1/4	1	HO XEE B05
1 1/2	1	HO XEE B06
2	1	HO XEE B07



SET OF TRANSPARENT SERVICE PLUGS AND WHITE PVC TAG HOLDERS - For insertion in handle for VXE Easyfit valve customisation

Size (inch/mm)	Standard pack quantity	Product Code
16-20 / 1/2	20	LCE020
25/3/4	20	LCE025
32/1	20	LCE032
40 / 1 1/4	20	LCE040
50 / 1 1/2	20	LCE050
63 / 2	20	LCE063



SET OF TRANSPARENT SERVICE PLUGS AND WHITE PVC TAG HOLDERS - For insertion in handle for VXE Easyfit valve customisation

Size (inch/mm)	No. of sheets	Total labels	Product Code
16-20 / 1/2	10	500	LSE020
25/3/4	10	500	LSE025
32/1	10	500	LSE032
40 / 1 1/4	10	500	LSE040
50 / 1 1/2	10	400	LSE050
63 / 2	10	400	LSE063



VKR METERING BALL VALVES - Manual - FKM seals

Size (inch)	Standard pack quantity	Product Code
3/8	1	HO MBF 101
1/2	1	HO MBF 102
3/4	1	HO MBF 103
1	1	HO MBF 104
1 1/4	1	HO MBF 105
1 1/2	1	HO MBF 106
2	1	HO MBF 107

Available with BSP threaded ends.

Durapipe PVC

Valves – Imperial



TKD 3-WAY BALL VALVES T-PORT BS SERIES, PLAIN FEMALE ENDS - EPDM seals

Size (inch)	Standard pack quantity	Product Code
1/2	1	HO TTE 102
3/4	1	HO TTE 103
1	1	HO TTE 104
1 1/4	1	HO TTE 105
1 1/2	1	HO TTE 106
2	1	HO TTE 107



TKD 3-WAY BALL VALVES T-PORT, PLAIN FEMALE ENDS - EPDM seals

Size (inch)	Standard pack quantity	Product Code
1/2	1	HO LTE 102
3/4	1	HO LTE 103
1	1	HO LTE 104
1 1/4	1	HO LTE 105
1 1/2	1	HO LTE 106
2	1	HO LTE 107



TKD 3-WAY BALL VALVES T-PORT, PLAIN FEMALE ENDS - FKM seals

Size (inch)	Standard pack quantity	Product Code
1/2	1	HO TTF 102
3/4	1	HO TTF 103
1	1	HO TTF 104
1 1/4	1	HO TTF 105
1 1/2	1	HO TTF 106
2	1	HO TTF 107



TKD 3-WAY BALL VALVES L-PORT, PLAIN FEMALE ENDS - FKM seals

Size (inch)	Standard pack quantity	Product Code
1/2	1	HO LTF 102
3/4	1	HO LTF 103
1	1	HO LTF 104
1 1/4	1	HO LTF 105
1 1/2	1	HO LTF 106
2	1	HO LTF 107



TKD 3-WAY BALL VALVES T-PORT, THREADED ENDS - EPDM seals

Size (inch)	Standard pack quantity	Product Code
1/2	1	HO TTE B02
3/4	1	HO TTE B03
1	1	HO TTE B04
1 1/4	1	HO TTE B05
1 1/2	1	HO TTE B06
2	1	HO TTE B07



TKD 3-WAY BALL VALVES L-PORT, THREADED ENDS - EPDM seals

Size (inch)	Standard pack quantity	Product Code
1/2	1	HO LTE B02
3/4	1	HO LTE B03
1	1	HO LTE B04
1 1/4	1	HO LTE B05
1 1/2	1	HO LTE B06
2	1	HO LTE B07

All TKD valves can be supplied with locking handles, available upon request.



SX EASYFIT BALL CHECK VALVES PLAIN FEMALE ENDS - EPDM seals

Size (inch)	Standard pack quantity	Product Code
1/2	1	HO SXE 102
3/4	1	HO SXE 103
1	1	HO SXE 104
1 1/4	1	HO SXE 105
1 1/2	1	HO SXE 106
2	1	HO SXE 107



SX EASYFIT BALL CHECK VALVES PLAIN FEMALE ENDS - FKM seals

Size (inch)	Standard pack quantity	Product Code
1/2	1	HO SXF 102
3/4	1	HO SXF 103
1	1	HO SXF 104
1 1/4	1	HO SXF 105
1 1/2	1	HO SXF 106
2	1	HO SXF 107

Durapipe PVC

Valves – Imperial



SX EASYFIT BALL CHECK VALVES BSP THREADED FEMALE ENDS - EPDM seals

Size (inch)	Standard pack quantity	Product Code
1/2	1	HO SXE B02
3/4	1	HO SXE B03
1	1	HO SXE B04
1 1/4	1	HO SXE B05
1 1/2	1	HO SXE B06
2	1	HO SXE B07

FKM seals available on request.



SX EASYFIT BALL CHECK VALVES PLAIN FEMALE ENDS - EPDM seals

Size (inch)	Standard pack quantity	Product Code
2 1/2	1	HO SXE 312
3	1	HO SXE 109
4	1	HO SXE 110



SX EASYFIT BALL CHECK VALVES BSP PLAIN FEMALE ENDS - FKM seals

Size (inch)	Standard pack quantity	Product Code
2 1/2	1	HO SXF B08
3	1	HO SXF B09
4	1	HO SXF B10



SA EASYFIT AIR RELEASE VALVES PLAIN FEMALE ENDS - EPDM seals

Size (inch)	Standard pack quantity	Product Code
1/2	1	HO SAE 102
3/4	1	HO SAE 103
1	1	HO SAE 104
1 1/4	1	HO SAE 105
1 1/2	1	HO SAE 106
2	1	HO SAE 107



SA EASYFIT AIR RELEASE VALVES PLAIN FEMALE ENDS - FKM seals

Size (inch)	Standard pack quantity	Product Code
1/2	1	HO SAF 102
3/4	1	HO SAF 103
1	1	HO SAF 104
1 1/4	1	HO SAF 105
1 1/2	1	HO SAF 106
2	1	HO SAF 107



SA EASYFIT AIR RELEASE VALVES BSP THREADED ENDS - EPDM seals

Size (inch)	Standard pack quantity	Product Code
1/2	1	HO SAE B02
3/4	1	HO SAE B03
1	1	HO SAE B04
1 1/4	1	HO SAE B05
1 1/2	1	HO SAE B06
2	1	HO SAE B07



RV Y-TYPE STRAINERS PLAIN ENDS - EPDM seals

Size (inch)	Standard pack quantity	Product Code
1/2	1	HO UVE 102
3/4	1	HO UVE 103
1	1	HO UVE 104
1 1/4	1	HO UVE 105
1 1/2	1	HO UVE 106
2	1	HO UVE 107



RV Y-TYPE STRAINERS PLAIN ENDS - FKM seals

Size (inch)	Standard pack quantity	Product Code
1/2	1	HO UVF 102
3/4	1	HO UVF 103
1	1	HO UVF 104
1 1/4	1	HO UVF 105
1 1/2	1	HO UVF 106
2	1	HO UVF 107

Durapipe PVC

Valves – Imperial



RV Y-TYPE TRANSPARENT STRAINERS PLAIN ENDS - EPDM seals

Size (inch)	Standard pack quantity	Product Code
1/2	1	HO UTE 102
3/4	1	HO UTE 103
1	1	HO UTE 104
1 1/4	1	HO UTE 105
1 1/2	1	HO UTE 106
2	1	HO UTE 107

A range of spare strainer screens are available upon request.



RV Y-TYPE TRANSPARENT STRAINERS PLAIN ENDS - FKM seals

Size (inch)	Standard pack quantity	Product Code
1/2	1	HO UTF 102
3/4	1	HO UTF 103
1	1	HO UTF 104
1 1/4	1	HO UTF 105
1 1/2	1	HO UTF 106
2	1	HO UTF 107

A range of spare/replacement strainer screens are available upon request.



DIALOCK® DIAPHRAGM VALVES MANUAL - PLAIN ENDS - EPDM Seals

Size (inch)	Standard pack quantity	Product Code
1/2	1	HO DVE 102
3/4	1	HO DVE 103
1	1	HO DVE 104
1 1/4	1	HO DVE 105
1 1/2	1	HO DVE 106
2	1	HO DVE 107
2 1/2	1	HO DVE 312

*2 1/2" product is supplied with plain spigot ends



DIALOCK® DIAPHRAGM VALVES MANUAL - PLAIN ENDS - FKM Seals

Size (inch)	Standard pack quantity	Product Code
1/2	1	HO DVF 102
3/4	1	HO DVF 103
1	1	HO DVF 104
1 1/4	1	HO DVF 105
1 1/2	1	HO DVF 106
2	1	HO DVF 107
2 1/2	1	HO DVF 312

*2 1/2" product is supplied with plain spigot ends



DIALOCK® DIAPHRAGM VALVES MANUAL - PLAIN UNION ENDS - PTFE Seals

Size (inch)	Standard pack quantity	Product Code
1/2	1	HO DVG 102
3/4	1	HO DVG 103
1	1	HO DVG 104
1 1/4	1	HO DVG 105
1 1/2	1	HO DVG 106
2	1	HO DVG 107
2 1/2	1	HO DVG 312

*2 1/2" product is supplied with plain spigot ends



DIALOCK® DIAPHRAGM VALVES MANUAL - BSP THREADED UNION ENDS - EPDM Seals

Size (inch)	Standard pack quantity	Product Code
1/2	1	HO DVE B02
3/4	1	HO DVE B03
1	1	HO DVE B04
1 1/4	1	HO DVE B05
1 1/2	1	HO DVE B06
2	1	HO DVE B07
2 1/2	1	HO DVE B08

*2 1/2" product is supplied with plain spigot ends



DIALOCK® DIAPHRAGM VALVES MANUAL - BSP THREADED UNION ENDS - FKM Seals

Size (inch)	Standard pack quantity	Product Code
1/2	1	HO DVF B02
3/4	1	HO DVF B03
1	1	HO DVF B04
1 1/4	1	HO DVF B05
1 1/2	1	HO DVF B06
2	1	HO DVF B07
2 1/2	1	HO DVF B08

*2 1/2" product is supplied with plain spigot ends



DIALOCK® DIAPHRAGM VALVES MANUAL - BSP THREADED UNION ENDS - PTFE Seals

Size (inch)	Standard pack quantity	Product Code
1/2	1	HO DVG B02
3/4	1	HO DVG B03
1	1	HO DVG B04
1 1/4	1	HO DVG B05
1 1/2	1	HO DVG B06
2	1	HO DVG B07
2 1/2	1	HO DVG B08

*2 1/2" product is supplied with plain spigot ends

Durapipe PVC

Valves – Imperial



VM DIAPHRAGM VALVES MANUAL – PLAIN SPIGOT ENDS – EPDM seals

Size (inch)	Standard pack quantity	Product Code
3	1	HO VME 209
4	1	HO VME 210



VM DIAPHRAGM VALVES MANUAL – PLAIN SPIGOT ENDS – FKM seals

Size (inch)	Standard pack quantity	Product Code
3	1	HO VMF 209
4	1	HO VMF 210



VM DIAPHRAGM VALVES MANUAL – PLAIN SPIGOT ENDS – PTFE seals

Size (inch)	Standard pack quantity	Product Code
3	1	HO VMG 209
4	1	HO VMG 210



LR PRESSURE/LOADING RELIEF VALVES PLAIN FEMALE ENDS – EPDM Seals

Size (inch)	Standard pack quantity	Product Code
½	1	HO LRE 102
¾	1	HO LRE 103
1	1	HO LRE 104
1¼	1	HO LRE 105
1½	1	HO LRE 106
2	1	HO LRE 107

FKM or PTFE seal options available upon request.



FK BUTTERFLY VALVES – Glass reinforced Polypropylene with PVC-U disc, EPDM liner – Lever operated

Size (inch)	Standard pack quantity	Product Code
1½	1	HO FKE 106
2	1	HO FKE 107
2½	1	HO FKE 108
3	1	HO FKE 109
4	1	HO FKE 110
5	1	HO FKE 111
6	1	HO FKE 112
8	1	HO FKE 113



FK BUTTERFLY VALVES – Glass reinforced Polypropylene with PVC-U disc, FKM liner – Lever operated

Size (inch)	Standard pack quantity	Product Code
1½	1	HO FKF 106
2	1	HO FKF 107
2½	1	HO FKF 108
3	1	HO FKF 109
4	1	HO FKF 110
5	1	HO FKF 111
6	1	HO FKF 112
8	1	HO FKF 113



FK BUTTERFLY VALVES – With gear box – EPDM Liner

Size (inch)	Standard pack quantity	Product Code
2½	1	HV FKE 108
3	1	HV FKE 109
4	1	HV FKE 110
5	1	HV FKE 111
6	1	HV FKE 112
8	1	HV FKE 113
10	1	HV FKE 114
12	1	HV FKE 115

ACTUATED VALVES AVAILABLE



For Actuated valves please visit our Actuation section on **pages 122-128**

FK BUTTERFLY VALVES – With gear box – FKM Liner

Size (inch)	Standard pack quantity	Product Code
2½	1	HV FKF 108
3	1	HV FKF 109
4	1	HV FKF 110
5	1	HV FKF 111
6	1	HV FKF 112
8	1	HV FKF 113
10	1	HV FKF 114
12	1	HV FKF 115

Lugged options also available please contact our valve department for further details.

Durapipe PVC

Metric system



PREMIUM PIPE – PVC-U PN10 ⁵⁵⁵

Pipe Diameter (mm)	Standard length in metres	Product Code
32	5	33 555 308
40	5	33 555 309
50	5	33 555 310
63	5	33 555 311
75	5	33 555 312
90	5	33 555 313
110*	5	33 555 314
125*	5	33 555 315
160*	5	33 555 317
200*	5	33 555 318
250*	5	33 555 320
315*	5	33 555 323

* Made to Order (Please refer to our Terms & Conditions).

Reg 31 & WRAS approved



PREMIUM PIPE – PVC-U PN16 ⁵⁶⁰

Pipe Diameter (mm)	Standard length in metres	Product Code
20	5	33 560 306
25	5	33 560 307
32	5	33 560 308
40	5	33 560 309
50	5	33 560 310
63	5	33 560 311
75	5	33 560 312
90	5	33 560 313
110	5	33 560 314

Reg 31 & WRAS approved



OPTIMA PIPE – PVC-U PN10 ⁵⁵⁶

Pipe Diameter (mm)	Standard length in metres	Product Code
32	5	33 556 308
40	5	33 556 309
50	5	33 556 310
63	5	33 556 311
75	5	33 556 312
90	5	33 556 313
110	5	33 556 314
125	5	33 556 315
160	5	33 556 317

WRAS approved



OPTIMA PIPE – PVC-U PN16 ⁵⁵⁷

Pipe Diameter (mm)	Standard length in metres	Product Code
20	5	33 557 306
25	5	33 557 307
32	5	33 557 308
40	5	33 557 309
50	5	33 557 310
63	5	33 557 311
75	5	33 557 312
90	5	33 557 313
110	5	33 557 314

WRAS approved



CLEAR PIPE – PVC-U ⁵⁵⁸

Pipe Diameter (mm)	Standard pack quantity	Product Code
16	5	33 558 305
20	5	33 558 306
25	5	33 558 307
32	5	33 558 308
40	5	33 558 309
50	5	33 558 310
63	5	33 558 311
75	5	33 558 312
90	5	33 558 313
110	5	33 558 314
125	5	33 558 315
140	5	33 558 316
160	5	33 558 317

Pressure Ratings: 16mm to 63mm (16 Bar) / 75mm to 110mm (10 Bar) / 125mm to 160mm (4 bar).

Minimum order quantities may apply

WRAS approved



SOCKETS – Plain ¹⁰⁰

Size (mm)	Standard pack quantity	Product Code
16	10	33 100 305
20	10	33 100 306
25	10	33 100 307
32	10	33 100 308
40	10	33 100 309
50	10	33 100 310
63	5	33 100 311
75	1	33 100 312
90	1	33 100 313
110	1	33 100 314
125	1	33 100 315
140	1	33 100 316
160	1	33 100 317
200	1	33 100 318
225	1	33 100 319
250**	1	33 100 320
315*	1	33 100 323

*PN10 rated at 20°C.
** Made to Order (Please refer to our Terms & Conditions).

Durapipe PVC

Metric system



REDUCING BUSHES - Plain 109

Size (mm)	Standard pack quantity	Product Code
20 x 16	10	33 109 412
25 x 20	10	33 109 415
32 x 20	10	33 109 418
32 x 25	10	33 109 419
40 x 20	10	33 109 421
40 x 25	10	33 109 422
40 x 32	10	33 109 423
50 x 32	10	33 109 426
50 x 40	10	33 109 427
63 x 32	5	33 109 430
63 x 40	5	33 109 431
63 x 50	5	33 109 432
75 x 50	2	33 109 437
75 x 63	2	33 109 438
90 x 50	2	33 109 442
90 x 63	2	33 109 443
90 x 75	2	33 109 444
110 x 75	2	33 109 450
110 x 90	2	33 109 451
125 x 110	1	33 109 459
140 x 90	1	33 109 465
140 x 110	1	33 109 466
140 x 125	1	33 109 467
160 x 90	1	33 109 473
160 x 110	1	33 109 474
160 x 140	1	33 109 476
200 x 160	1	33 109 487
225 x 160	1	33 109 495
225 x 200	1	33 109 496
250 x 160**	1	33 109 497
250 x 200**	1	33 109 498
250 x 225**	1	33 109 499
315 x 200*	1	33 109 536
315 x 225*	1	33 109 502
315 x 250*	1	33 109 503

*PN10 rated at 20°C.

** Made to Order (Please refer to our Terms & Conditions).



REDUCERS - Plain/spigot x plain 114

Size (mm)	Standard pack quantity	Product Code
*20 x 16	10	33 114 305
(25 or 20) x 16	10	33 114 412
(25 or 20) x 20	10	33 114 306
(32 or 25) x 16	10	33 114 414
(32 or 25) x 20	10	33 114 415
(32 or 25) x 25	10	33 114 307
(40 or 32) x 20	10	33 114 418
(40 or 32) x 25	10	33 114 419
(40 or 32) x 32	10	33 114 308
(50 or 40) x 20	10	33 114 421
(50 or 40) x 25	10	33 114 422
(50 or 40) x 32	10	33 114 423
(50 or 40) x 40	10	33 114 309
(63 or 50) x 25	5	33 114 425
(63 or 50) x 32	5	33 114 426
(63 or 50) x 40	5	33 114 427
(63 or 50) x 50	5	33 114 310
(75 or 63) x 50	2	33 114 432
(75 or 63) x 63	2	33 114 311
(90 or 75) x 40	2	33 114 436
(90 or 75) x 50	2	33 114 437
(90 or 75) x 63	2	33 114 438
(90 or 75) x 75	2	33 114 312
(110 or 90) x 50	1	33 114 442
(110 or 90) x 63	1	33 114 443
(110 or 90) x 75	1	33 114 444
*160 x 110	1	33 114 474

*Spigot/socket.



ELBOWS 45° - Plain 119

Size (mm)	Standard pack quantity	Product Code
16	10	33 119 305
20	10	33 119 306
25	10	33 119 307
32	10	33 119 308
40	5	33 119 309
50	5	33 119 310
63	5	33 119 311
75	1	33 119 312
90	1	33 119 313
110	1	33 119 314
125	1	33 119 315
140	1	33 119 316
160	1	33 119 317
200*	1	33 119 318
225*	1	33 119 319
250**	1	33 119 320
315**	1	33 119 323

* PN10 rated at 20°C.

** Made to Order (Please refer to our Terms & Conditions).



ELBOWS 90° - Plain 115

Size (mm)	Standard pack quantity	Product Code
16	10	33 115 305
20	10	33 115 306
25	10	33 115 307
32	10	33 115 308
40	10	33 115 309
50	10	33 115 310
63	5	33 115 311
75	1	33 115 312
90	1	33 115 313
110	1	33 115 314
125	1	33 115 315
140	1	33 115 316
160	1	33 115 317
200	1	33 115 318
225	1	33 115 319
250*	1	33 115 320
315**	1	33 115 323

* PN10 rated at 20°C.

** Made to Order (Please refer to our Terms & Conditions).



TEES 45° - Plain 418

Size (mm)	Standard pack quantity	Product Code
20	5	33 418 306
25	5	33 418 307
32	5	33 418 308
40	5	33 418 309
50	5	33 418 310
63	5	33 418 311

Durapipe PVC

Metric system



TEES 90° EQUAL- Plain 122

Size (mm)	Standard pack quantity	Product Code
16	10	33 122 305
20	10	33 122 306
25	10	33 122 307
32	10	33 122 308
40	10	33 122 309
50	10	33 122 310
63	5	33 122 311
75	1	33 122 312
90	1	33 122 313
110	1	33 122 314
125	1	33 122 315
140	1	33 122 316
160	1	33 122 317
200	1	33 122 318
225	1	33 122 319
250*	1	33 122 320
315**	1	33 122 323

* PN10 rated at 20°C.

** Made to Order (Please refer to our Terms & Conditions).



CROSS - Plain 108

Size (mm)	Standard pack quantity	Product Code
25	10	33 108 307
32	10	33 108 308
40	10	33 108 309
50	10	33 108 310
63	5	33 108 311



TEES 90° REDUCING - Plain 124

Size (mm)	Standard pack quantity	Product Code
25 x 20	10	33 124 415
32 x 20	10	33 124 418
32 x 25	10	33 124 419
40 x 20	10	33 124 421
40 x 25	10	33 124 422
40 x 32	10	33 124 423
50 x 20	10	33 124 424
50 x 25	10	33 124 425
50 x 32	10	33 124 426
50 x 40	10	33 124 427
63 x 25	5	33 124 429
63 x 32	5	33 124 430
63 x 40	5	33 124 431
63 x 50	5	33 124 432



SOCKET UNIONS - Plain EPDM 205

Size (mm)	Standard pack quantity	Product Code
16	10	33 205 305
20	10	33 205 306
25	10	33 205 307
32	10	33 205 308
40	10	33 205 309
50	10	33 205 310
63	5	33 205 311
75	1	33 205 312
90	1	33 205 313
110	1	33 205 314

*Larger sizes up to 315mm available upon request. FKM seals available on request.



SOCKET UNIONS - Plain FKM 204

Size (mm)	Standard pack quantity	Product Code
16	10	33 204 305
20	10	33 204 306
25	10	33 204 307
32	10	33 204 308
40	10	33 204 309
50	10	33 204 310
63	5	33 204 311
75	1	33 204 312
90	1	33 204 313
110	1	33 204 314



BENDS 90° - Short radius 118

Size (mm)	Standard pack quantity	Product Code
20	5	33 118 306
25	5	33 118 307
32	5	33 118 308
40	5	33 118 309
50	2	33 118 310
63	1	33 118 311
75	1	33 118 312
90	1	33 118 313
110	1	33 118 314
160*	1	33 118 317

*PN10 rated.



END CAPS - Plain 140

Size (mm)	Standard pack quantity	Product Code
16	10	33 140 305
20	10	33 140 306
25	10	33 140 307
32	10	33 140 308
40	10	33 140 309
50	10	33 140 310
63	5	33 140 311
75	1	33 140 312
90	1	33 140 313
110	1	33 140 314
160	1	33 140 317
225	1	33 140 319



IMPERIAL/METRIC SOCKET ADAPTORS - Plain 345/100

Size (mm/inch)	Standard pack quantity	Product Code
20 x 1/2	10	33 345 102
25 x 3/4	10	33 345 103
32 x 1	10	33 345 104
40 x 1 1/4	10	33 345 105
50 x 1 1/2	10	33 345 106
63 x 2	5	33 345 107
75 x 2 1/2	5	33 100 312
90 x 3	5	33 345 109
110 x 4	1	33 345 110

Durapipe PVC

Metric system



SOCKETS - Plain/female BSP thread
101

Size (mm/inch)	Standard pack quantity	Product Code
20 x 1/2	10	33 101 102
25 x 3/4	10	33 101 103
32 x 1	10	33 101 104
40 x 1 1/4	10	33 101 105
50 x 1 1/2	10	33 101 106
63 x 2	5	33 101 107



SOCKETS - Plain/female BSP thread with metal reinforcing ring 103

Size (mm/inch)	Standard pack quantity	Product Code
20 x 1/2	10	33 103 102
25 x 3/4	10	33 103 103
32 x 1	10	33 103 104
40 x 1 1/4	10	33 103 105
50 x 1 1/2	10	33 103 106
63 x 2	5	33 103 107



REDUCERS (DIFV) - Plain spigot/female BSP thread 169

Size (mm)	Standard pack quantity	Product Code
20 x 16 x 3/8	10	33 169 101
25 x 20 x 1/2	10	33 169 102
32 x 25 x 3/4	10	33 169 103
40 x 32 x 1	10	33 169 104
50 x 40 x 1 1/4	10	33 169 105
63 x 50 x 1 1/2	5	33 169 106
90 x 75 x 2 1/2	5	33 169 108
110 x 90 x 3	5	33 169 109
125 x 110 x 4	5	33 169 110



FEMALE THREADED ADAPTORS (DIMV) - Plain spigot/plain socket/female BSP thread 170/153

Size (mm/inch)	Standard pack quantity	Product Code
20 x 16 x 3/8	10	33 170 101
20 x 16 x 1/2	10	33 153 333
25 x 20 x 1/2	10	33 170 102
25 x 20 x 3/4	10	33 153 335
32 x 25 x 3/4	10	33 170 103
32 x 25 x 1	10	33 153 337
40 x 32 x 1	10	33 170 104
40 x 32 x 1 1/4	5	33 153 339
50 x 40 x 1 1/4	10	33 170 105
50 x 40 x 1 1/2	5	33 153 341
63 x 50 x 1 1/2	5	33 170 106
63 x 50 x 2	5	33 153 343



MALE THREADED ADAPTORS (KIFV) - Plain spigot/plain socket/male BSP thread 151

Size (mm/inch)	Standard pack quantity	Product Code
16 x 12 x 3/8	10	33 151 331
20 x 16 x 3/8	10	33 151 332
20 x 16 x 1/2	10	33 151 333
25 x 20 x 1/2	10	33 151 334
25 x 20 x 3/4	10	33 151 335
32 x 25 x 1/2	10	33 151 352
32 x 25 x 3/4	10	33 151 336
32 x 25 x 1	10	33 151 337
40 x 32 x 3/4	10	33 151 353
40 x 32 x 1	10	33 151 338
40 x 32 x 1 1/4	10	33 151 339
50 x 40 x 1	5	33 151 354
50 x 40 x 1 1/4	10	33 151 340
50 x 40 x 1 1/2	5	33 151 341
63 x 50 x 1 1/4	10	33 151 355
63 x 50 x 1 1/2	5	33 151 342
63 x 50 x 2	5	33 151 343
75 x 63 x 1 1/2	2	33 151 356
75 x 63 x 2	5	33 151 345
90 x 75 x 2	2	33 151 346
90 x 75 x 2 1/2	2	33 151 347
90 x 75 x 3	2	33 151 357
110 x 90 x 3	2	33 151 348
110 x 90 x 4	2	33 151 358
125 x 110 x 4	1	33 151 349
63 x 50 x 1 1/2	5	33 170 106
63 x 50 x 2	5	33 153 343



HOSE ADAPTORS - Female BSP thread/hose tail 156

Size (mm/inch)	Standard pack quantity	Product Code
14 x 12 x 1/2	10	02 156 601
18 x 16 x 3/4	10	02 156 603
22 x 20 x 1	10	02 156 606
27 x 25 x 1 1/4	10	02 156 609
32 x 30 x 1 1/2	5	02 156 613
42 x 40 x 2	5	02 156 616
52 x 50 x 2 1/4	5	02 156 623
64 x 60 x 2 1/2	1	02 156 612
64 x 60 x 2 3/4	1	02 156 630



HOSE ADAPTORS - Male BSP thread/hose tail 157

Size (mm/inch)	Standard pack quantity	Product Code
14 x 12 x 3/4	10	02 157 600
18 x 16 x 3/8	10	02 157 602
22 x 20 x 1/2	10	02 157 605
27 x 25 x 3/4	10	02 157 608
32 x 30 x 1	10	02 157 612
42 x 40 x 1 1/4	10	02 157 616
52 x 50 x 1 1/2	5	02 157 622
64 x 60 x 2	5	02 157 629



HOSE ADAPTORS - Plain spigot/hose tail 158

Size (mm)	Standard pack quantity	Product Code
12 x 14 x 12	10	33 158 304
16 x 18 x 16	10	33 158 305
20 x 22 x 20	10	33 158 306
25 x 27 x 25	10	33 158 307
32 x 32 x 30	10	33 158 308
40 x 42 x 40	5	33 158 309
50 x 52 x 50	5	33 158 310
63 x 64 x 60	5	33 158 311



TANK CONNECTORS - Plain spigot male BSP thread 235

Size (mm/inch)	Standard pack quantity	Product Code
16 x 1/2	5	33 235 305
20 x 3/4	5	33 235 306
25 x 1	5	33 235 307
32 x 1	2	33 235 308
40 x 1 1/2	5	33 235 310



SADDLE CLAMPS - Bolt on female BSP threaded branch 436

Size (mm/inch)	Standard pack quantity	Product Code
32 x 1/2*	1	33 436 201
32 x 3/4*	1	33 436 202
40 x 3/4*	1	33 436 204
40 x 1*	1	33 436 205
50 x 1/2*	1	33 436 206
50 x 3/4*	1	33 436 207
50 x 1*	1	33 436 208
63 x 1/2*	1	33 436 209
63 x 3/4*	1	33 436 210
63 x 1*	1	33 436 211
63 x 1 1/2*	1	33 436 212
75 x 3/4*	1	33 436 213
75 x 1*	1	33 436 214
90 x 3/4*	1	33 436 216
90 x 1*	1	33 436 217
90 x 1 1/2*	1	33 436 219
90 x 2*	1	33 436 220
110 x 3/4*	1	33 436 221
110 x 1*	1	33 436 222
110 x 1 1/2*	1	33 436 224
110 x 2*	1	33 436 225
125 x 1*	1	33 436 226
125 x 1 1/2*	1	33 436 228
125 x 2*	1	33 436 229
140 x 1*	1	33 436 230
140 x 1 1/2*	1	33 436 232
140 x 2*	1	33 436 233
160 x 1*	1	33 436 234
160 x 1 1/2*	1	33 436 236
160 x 2*	1	33 436 237
200 x 2*	1	33 436 238
225 x 1 1/2*	1	33 436 239
225 x 2*	1	33 436 240
225 x 3*	1	33 436 241

* Made to Order (Please refer to our Terms & Conditions).

Note: Saddle clamps are fitted with NBR gaskets so are only suitable for water applications. For more information contact our technical support team.



COMPOSITE UNIONS - Plain socket/brass female BSP parallel thread 222

Size (mm/inch)	Standard pack quantity	Product Code
16 x 3/8	5	33 216 305
20 x 1/2	5	33 222 306
25 x 3/4	5	33 222 307
32 x 1	2	33 222 308
40 x 1 1/4	2	33 222 309
50 x 1 1/2	2	33 222 310
63 x 2	2	33 222 311



COMPOSITE UNIONS - Plain socket/brass male BSP taper thread 223

Size (mm/inch)	Standard pack quantity	Product Code
16 x 3/8	5	33 217 305
20 x 1/2	5	33 223 306
25 x 3/4	5	33 223 307
32 x 1	2	33 223 308
40 x 1 1/4	2	33 223 309
50 x 1 1/2	2	33 223 310
63 x 2	2	33 223 311



SS FEMALE COMPOSITE UNIONS - PVC/Stainless Steel 316L, BSP female parallel thread 218

Size (mm/inch)	Standard pack quantity	Product Code
20 x 1/2	10	33 218 306
25 x 3/4	10	33 218 307
32 x 1	10	33 218 308
40 x 1 1/4	5	33 218 309
50 x 1 1/2	5	33 218 310
63 x 2	5	33 218 311



SS MALE COMPOSITE UNIONS - PVC/Stainless Steel 316L, BSP male taper thread 219

Size (mm/inch)	Standard pack quantity	Product Code
20 x 1/2	10	33 219 306
25 x 3/4	10	33 219 307
32 x 1	10	33 219 308
40 x 1 1/4	5	33 219 309
50 x 1 1/2	5	33 219 310
63 x 2	5	33 219 311

Durapipe PVC

Metric system



ELBOWS 90° - Plain socket/female BSP thread ¹¹⁶

Size (mm/inch)	Standard pack quantity	Product Code
20 x 1/2	10	33 116 102
25 x 3/4	10	33 116 103
32 x 1	10	33 116 104
40 x 1 1/4	10	33 116 105
50 x 1 1/2	10	33 116 106
63 x 2	5	33 116 107
75 x 2 1/2	1	33 116 108
90 x 3	1	33 116 109
110 x 4	1	33 116 110



ELBOWS 90° - Plain socket/female BSP thread with metal reinforcing ring ¹⁷⁸

Size (mm/inch)	Standard pack quantity	Product Code
16 x 3/8	10	33 178 101
20 x 1/2	10	33 178 102
25 x 3/4	10	33 178 103
32 x 1	10	33 178 104
40 x 1 1/4	10	33 178 105
50 x 1 1/2	10	33 178 106
63 x 2	5	33 178 107
90 x 3	1	33 116 109
110 x 4	1	33 116 110



TEES 90° - Plain socket/female BSP threaded branch ¹⁴⁶

Size (mm/inch)	Standard pack quantity	Product Code
16 x 3/8	10	33 146 602
20 x 1/2	10	33 146 605
25 x 3/4	10	33 146 608
32 x 1	10	33 146 610
32 x 1*	10	33 146 612
40 x 1 1/4	10	33 146 616
50 x 1 1/2	10	33 146 618
50 x 1 1/2*	10	33 146 622
63 x 1 1/2	5	33 146 624
63 x 2*	5	33 146 629
75 x 2 1/2	1	33 146 636
90 x 3*	1	33 146 644
110 x 4*	1	33 146 652

* Made to Order (Please refer to our Terms & Conditions).



TEES 90° - Plain sockets/female BSP threaded branch with ¹²³

Size (mm/inch)	Standard pack quantity	Product Code
20 x 1/2	10	33 123 605
25 x 3/4	10	33 123 608
32 x 1	10	33 123 612
40 x 1 1/4	10	33 123 616
50 x 1 1/2	10	33 123 622
63 x 2	5	33 123 629



CLEAR PVC-U STATIC MIXER (EPDM)

Size (inch)	Number of mixer elements	Product Code
20	6	SMC 6E 306
20	12	SMC 12E 306
25	6	SMC 6E 307
25	12	SMC 12E 307
32	6	SMC 6E 308
32	12	SMC 12E 308
40	6	SMC 6E 309
40	12	SMC 12E 309
50	6	SMC 6E 310
50	12	SMC 12E 310
63	6	SMC 6E 311
63	12	SMC 12E 311

FKM seals available.



FLANGES FULL FACE - Plain/drilled ³¹⁹

Size (mm)	Standard pack quantity	Product Code
Drilled to BS EN1092-1, PN10 (Formerly BS 4504)		
25	2	33 319 307
32	2	33 319 308
40	2	33 319 309
50	2	33 319 310
63	2	33 319 311
75	2	33 319 312
90	2	33 319 313
110	2	33 319 314

Also matches PN16 drillings.



FLANGES STUB - Plain/serrated face ^{133/135}

Size (mm)	Standard pack quantity	Product Code
20	10	33 133 306*
25	10	33 133 307*
32	10	33 133 308*
40	10	33 135 309
50	2	33 135 310
63	2	33 135 311
75	2	33 135 312
90	1	33 135 313
110	1	33 135 314
125	1	33 135 315
140	1	33 135 316
160	1	33 135 317
200	1	33 135 318
225	1	33 135 319
250	1	33 135 320
315**	1	33 135 323

* Flat face.

** Made to Order (Please refer to our Terms & Conditions).

Durapipe PVC

Metric system



BACKING RINGS - Galvanised mild steel - suitable for use with stub and full face flanges ^{421/420/448}

Size (mm)	Standard pack quantity	Product Code
Drilled to BS EN1092-1, PN10/PN16 (Formerly BS 4504)		
16	1	13 421 305
20	1	13 421 306
25	1	13 421 307
32	1	13 421 308
40	1	13 421 309
50	1	13 421 310
63	1	13 421 311
75	1	13 421 312
90	1	13 421 313
110	1	13 421 314
125	1	13 421 315
140	1	13 421 316
160	1	13 421 317
200	1	13 421 318
225	1	13 421 319
250	1	13 421 320
315	1	13 421 323
Drilled to BS EN1092-1, PN10 (Formerly BS 4504)		
200	1	13 420 318
225	1	13 420 319
250	1	13 420 320
315	1	13 420 323



BACKING RINGS - PVC-U - suitable for use with stub flanges ¹⁸⁰

Size (mm)	Standard pack quantity	Product Code
Drilled to ANSI Class 150		
20	1	13 448 306
25	1	13 448 307
32	1	13 448 308
40	1	13 448 309
50	1	13 448 310
63	1	13 448 311
75	1	13 448 312
90	1	13 448 313
110	1	13 448 314
125	1	13 448 315
140	1	13 448 316
160	1	13 448 317
200	1	13 448 318
225	1	13 448 319

Size (mm)	Standard pack quantity	Product Code
Drilled to BS EN1092-1, PN10/PN16 (Formerly BS 4504)		
20	2	33 180 306
25	2	33 180 307
32	2	33 180 308
40	2	33 180 309
50	2	33 180 310
63	2	33 180 311
75	2	33 180 312
90	2	33 180 313
110	1	33 180 314
125	1	33 180 315
140	1	33 180 316
160	1	33 180 317
200	1	33 180 318
250	1	33 180 320
315	1	33 180 323

PP/FRP STEEL CORE BACKING RINGS - DIN2501 drilled to PN10/16 ⁴²¹

Size (mm)	Standard pack quantity	Product Code
20*	1	18 421 306
25*	1	18 421 307
32*	1	18 421 308
40*	1	18 421 309
50*	1	18 421 310
63*	1	18 421 311
75*	1	18 421 312
90*	1	18 421 313
110*	1	18 421 314
125*	1	18 421 315
140*	1	18 421 316
160*	1	18 421 317
200*	1	18 421 318
225*	1	18 421 319
250*	1	18 421 320
315*	1	18 421 323

* Made to Order (Please refer to our Terms & Conditions).

Durapipe PVC

Metric system



PP/FRP STEEL CORE BACKING RINGS - ANSI drilled 448

Size (mm)	Standard pack quantity	Product Code
20*	1	18 448 306
25*	1	18 448 307
32*	1	18 448 308
40*	1	18 448 309
50*	1	18 448 310
63*	1	18 448 311
75*	1	18 448 312
90*	1	18 448 313
110*	1	18 448 314
125*	1	18 448 317
140*	1	18 448 318
160*	1	18 448 320
200*	1	18 448 323
225*	1	18 421 319
250*	1	18 421 320
315*	1	18 421 323

* Made to Order (Please refer to our Terms & Conditions).



GASKETS FLAT - EPDM for use with stub flanges 411/431

Size (mm)	Standard pack quantity	Product Code
16	10	13 411 305
20	10	13 411 306
25	10	13 411 307
32	10	13 411 308
40	10	13 411 309
50	10	13 411 310
63	10	13 411 311
75	10	13 411 312
90	10	13 411 313
110	10	13 411 314
125	10	13 411 315
140	10	13 411 316
160	10	13 411 317
200	10	13 411 318
225	10	13 411 319
250	10	13 431 320
315	10	13 411 323

* Made to Order (Please refer to our Terms & Conditions).



VALVE SUPPORT PLATES - Galvanised mild steel, drilled 459

Size (mm)	Standard pack quantity	Product Code
16	1	31 459 305
20	1	31 459 306
25	1	31 459 307
32	1	31 459 308
50	1	31 459 310
63	1	31 459 311
75	1	31 459 312
90	1	31 459 313
110	1	31 459 314

Drilled to BS EN1092-1, PN10/PN16 (Formerly BS 4504)

Durapipe PVC

Valves Metric



VKD DOUBLE UNION BALL VALVES MANUAL - EPDM seals

Size (mm)	Standard pack quantity	Product Code
16	1	HO DKE 305
20	1	HO DKE 306
25	1	HO DKE 307
32	1	HO DKE 308
40	1	HO DKE 309
50	1	HO DKE 310
63	1	HO DKE 311



VKD DOUBLE UNION BALL VALVES MANUAL LOCKING HANDLE - EPDM seals

Size (mm)	Standard pack quantity	Product Code
16	1	HO DLE 305
20	1	HO DLE 306
25	1	HO DLE 307
32	1	HO DLE 308
40	1	HO DLE 309
50	1	HO DLE 310
63	1	HO DLE 311



VKD DOUBLE UNION BALL VALVES MANUAL - FKM seals

Size (mm)	Standard pack quantity	Product Code
16	1	HO DKF 305
20	1	HO DKF 306
25	1	HO DKF 307
32	1	HO DKF 308
40	1	HO DKF 309
50	1	HO DKF 310
63	1	HO DKF 311



VKD DOUBLE UNION BALL VALVES MANUAL LOCKING HANDLE - FKM seals

Size (mm)	Standard pack quantity	Product Code
16	1	HO DLF 305
20	1	HO DLF 306
25	1	HO DLF 307
32	1	HO DLF 308
40	1	HO DLF 309
50	1	HO DLF 310
63	1	HO DLF 311



VXD DOUBLE UNION BALL VALVES MANUAL - EPDM seals

Size (mm)	Standard pack quantity	Product Code
75	1	HO DKE 312
90	1	HO DKE 313
110	1	HO DKE 314

Lockable handle as standard.



VXD DOUBLE UNION BALL VALVES MANUAL - FKM seals

Size (mm)	Standard pack quantity	Product Code
75	1	HO DKF 312
90	1	HO DKF 313
110	1	HO DKF 314

Lockable handle as standard.



VXE EASYFIT DOUBLE UNION BALL VALVES - Manual - EPDM seals

Size (mm)	Standard pack quantity	Product Code
20	1	HO XEE 306
25	1	HO XEE 307
32	1	HO XEE 308
40	1	HO XEE 309
50	1	HO XEE 310
63	1	HO XEE 311
75*	1	HO XEE 312
90*	1	HO XEE 313
110*	1	HO XEE 314

* FIG B product supplied.



VXE EASYFIT DOUBLE UNION BALL VALVES - Manual - FKM seals

Size (mm)	Standard pack quantity	Product Code
20	1	HO XEF 306
25	1	HO XEF 307
32	1	HO XEF 308
40	1	HO XEF 309
50	1	HO XEF 310
63	1	HO XEF 311
75*	1	HO XEF 312
90*	1	HO XEF 313
110*	1	HO XEF 314

* FIG B product supplied.

All VKD, VXE, TKD Ball valves are also available with BSP threaded ends, see PVC-U imperial section for details. Silicone-Free valves available upon request

Durapipe PVC

Valves Metric



SET OF TRANSPARENT SERVICE PLUGS AND WHITE PVC TAG HOLDERS - For insertion in handle for VXE Easyfit valve customisation

Size (mm/inch)	Standard pack quantity	Product Code
16-20 / 1/2	20	LCE020
25 / 3/4	20	LCE025
32 / 1	20	LCE032
40 / 1 1/4	20	LCE040
50 / 1 1/2	20	LCE050
63 / 2	20	LCE063



DIE CUT LABELS PLUS SOFTWARE - White waterproof A4 sheets and freeware editing software to be used with inkjet printers for VXE Easyfit valve customisation

Size (mm/inch)	No. of sheets	Total labels	Product Code
16-20 / 1/2	10	500	LSE020
25 / 3/4	10	500	LSE025
32 / 1	10	500	LSE032
40 / 1 1/4	10	500	LSE040
50 / 1 1/2	10	400	LSE050
63 / 2	10	400	LSE063



VKR METERING BALL VALVES MANUAL - EPDM seals

Size (mm)	Standard pack quantity	Product Code
16	1	HO MBE 305
20	1	HO MBE 306
25	1	HO MBE 307
32	1	HO MBE 308
40	1	HO MBE 309
50	1	HO MBE 310
63	1	HO MBE 311



VKR METERING BALL VALVES MANUAL - FKM seals

Size (mm)	Standard pack quantity	Product Code
16	1	HO MBF 305
20	1	HO MBF 306
25	1	HO MBF 307
32	1	HO MBF 308
40	1	HO MBF 309
50	1	HO MBF 310
63	1	HO MBF 311



TKD 3-WAY BALL VALVES T-PORT PLAIN FEMALE ENDS - EPDM seals

Size (mm)	Standard pack quantity	Product Code
20	1	HO TTE 306
25	1	HO TTE 307
32	1	HO TTE 308
40	1	HO TTE 309
50	1	HO TTE 310
63	1	HO TTE 311



TKD 3-WAY BALL VALVES L-PORT - Plain female ends - EPDM seals

Size (mm)	Standard pack quantity	Product Code
20	1	HO LTE 306
25	1	HO LTE 307
32	1	HO LTE 308
40	1	HO LTE 309
50	1	HO LTE 310
63	1	HO LTE 311



TKD 3-WAY BALL VALVES T-PORT - Plain female ends - FKM seals

Size (mm)	Standard pack quantity	Product Code
20	1	HO TTF 306
25	1	HO TTF 307
32	1	HO TTF 308
40	1	HO TTF 309
50	1	HO TTF 310
63	1	HO TTF 311



TKD 3-WAY BALL VALVES L-PORT - Plain female ends - FKM seals

Size (mm)	Standard pack quantity	Product Code
20	1	HO LTF 306
25	1	HO LTF 307
32	1	HO LTF 308
40	1	HO LTF 309
50	1	HO LTF 310
63	1	HO LTF 311

All TKD valves available with locking handle upon request

Durapipe PVC

Valves Metric



SX EASYFIT BALL CHECK VALVES - Plain female ends - EPDM seals

Size (mm)	Standard pack quantity	Product Code
20	1	HO SXE 306
25	1	HO SXE 307
32	1	HO SXE 308
40	1	HO SXE 309
50	1	HO SXE 310
63	1	HO SXE 311



SX EASYFIT BALL CHECK VALVES - Plain female ends - FKM seals

Size (mm)	Standard pack quantity	Product Code
20	1	HO SXF 306
25	1	HO SXF 307
32	1	HO SXF 308
40	1	HO SXF 309
50	1	HO SXF 310
63	1	HO SXF 311

All TKD valves available with locking handle upon request



SX EASYFIT BALL CHECK VALVES - Plain female ends - EPDM seals

Size (mm)	Standard pack quantity	Product Code
75	1	HO SXE 312
90	1	HO SXE 313
110	1	HO SXE 314



SX EASYFIT BALL CHECK VALVES - Plain female ends - FKM seals

Size (mm)	Standard pack quantity	Product Code
75	1	HO SXF 312
90	1	HO SXF 313
110	1	HO SXF 314



SA EASYFIT AIR RELEASE VALVES - Plain female ends - EPDM seals

Size (mm)	Standard pack quantity	Product Code
20	1	HO SAE 306
25	1	HO SAE 307
32	1	HO SAE 308
40	1	HO SAE 309
50	1	HO SAE 310
63	1	HO SAE 311



SA EASYFIT AIR RELEASE VALVES - Plain female ends - FKM seals

Size (mm)	Standard pack quantity	Product Code
20	1	HO SAF 306
25	1	HO SAF 307
32	1	HO SAF 308
40	1	HO SAF 309
50	1	HO SAF 310
63	1	HO SAF 311



RV Y-TYPE STRAINERS - Union ends - EPDM seals

Size (mm)	Standard pack quantity	Product Code
16	1	HO UVE 305
20	1	HO UVE 306
25	1	HO UVE 307
32	1	HO UVE 308
40	1	HO UVE 309
50	1	HO UVE 310
63	1	HO UVE 311



RV Y-TYPE STRAINERS - Union ends - FKM seals

Size (mm)	Standard pack quantity	Product Code
16	1	HO UVF 305
20	1	HO UVF 306
25	1	HO UVF 307
32	1	HO UVF 308
40	1	HO UVF 309
50	1	HO UVF 310
63	1	HO UVF 311



RV Y-TYPE TRANSPARENT STRAINERS - Union ends - EPDM seals

Size (mm)	Standard pack quantity	Product Code
16	1	HO UTE 305
20	1	HO UTE 306
25	1	HO UTE 307
32	1	HO UTE 308
40	1	HO UTE 309
50	1	HO UTE 310
63	1	HO UTE 311

All VKD, VXE, TKD Ball valves are also available with BSP threaded ends, see PVC-U imperial section for details. Silicone-Free valves available upon request

All VKD, VXE, TKD Ball valves are also available with BSP threaded ends, see PVC-U imperial section for details. Silicone-Free valves available upon request

Durapipe PVC

Valves Metric



RV Y-TYPE TRANSPARENT STRAINERS - Union ends - FKM seals

Size (mm)	Standard pack quantity	Product Code
16	1	HO UTF 306
20	1	HO UTF 306
25	1	HO UTF 307
32	1	HO UTF 308
40	1	HO UTF 309
50	1	HO UTF 310
63	1	HO UTF 311



DIALOCK® DIAPHRAGM VALVES MANUAL - Plain Union Ends - EPDM Seals

Size (mm)	Standard pack quantity	Product Code
20	1	HO DVE 306
25	1	HO DVE 307
32	1	HO DVE 308
40	1	HO DVE 309
50	1	HO DVE 310
63	1	HO DVE 311
75*	1	HO DVE 312

*75MM product supplied with plain spigot ends.



DIALOCK® DIAPHRAGM VALVES MANUAL - Plain Union Ends - FKM seals

Size (mm)	Standard pack quantity	Product Code
20	1	HO DVF 306
25	1	HO DVF 307
32	1	HO DVF 308
40	1	HO DVF 309
50	1	HO DVF 310
63	1	HO DVF 311
75*	1	HO DVF 312

*75MM product supplied with plain spigot ends.



DIALOCK® DIAPHRAGM VALVES MANUAL - Plain Union Ends - PTFE seals

Size (mm)	Standard pack quantity	Product Code
20	1	HO DVG 306
25	1	HO DVG 307
32	1	HO DVG 308
40	1	HO DVG 309
50	1	HO DVG 310
63	1	HO DVG 311
75*	1	HO DVG 312



VM DIAPHRAGM VALVES - Manual - plain spigot ends - EPDM seals

Size (mm)	Standard pack quantity	Product Code
90	1	HO VME 413
110	1	HO VME 414



VM DIAPHRAGM VALVES - Manual - plain spigot ends - FKM seals

Size (mm)	Standard pack quantity	Product Code
90	1	HO VMF 413
110	1	HO VMF 414



VM DIAPHRAGM VALVES - Manual - plain spigot ends - PTFE seals

Size (mm)	Standard pack quantity	Product Code
90	1	HO VMG 413
110	1	HO VMG 414



LR PRESSURE/LOADING RELIEF VALVES - Plain Union Ends - EPDM Seals

Size (mm)	Standard pack quantity	Product Code
16	1	HO LRE 305
20	1	HO LRE 306
25	1	HO LRE 307
32	1	HO LRE 308
40	1	HO LRE 309
50	1	HO LRE 310
63	1	HO LRE 311

*FKM or PTFE Seals available upon request

Actuated Valves available



For Actuated valves please visit our Actuation section on **pages 122-130**

Durapipe PVC

Accessories



PVC-U ONE-STEP SOLVENT CEMENT

Contents	Standard pack quantity	Product Code
½ litre	12	03 462 395



PVC-U RH THF FREE SOLVENT CEMENT

Contents	Standard pack quantity	Product Code
½ litre	12	03 462 397

Plain socket and spigot fittings are designed for cold solvent cement jointing. Durapipe PVC-U solvent cement must be used for jointing.



ECO CLEANER

Contents	Standard pack quantity	Product Code
½ litre	12	03 457 395



HCR-36 CHEMICALLY RESISTANT PVC CEMENT

Contents	Standard pack quantity	Product Code
1 litre	1	03 468 396



CLEANER FOR USE WITH HCR-36 CHEMICALLY RESISTANT PVC CEMENT

Contents	Standard pack quantity	Product Code
½ litre	1	03 467 395



COBRA PIPE CLIPS

Size (inch/mm)	Standard pack quantity	Product Code
12mm	10	13 434 304
3/8/16	10	13 434 305
1/2/20	10	13 434 306
3/4/25	10	13 434 307
1/32	10	13 434 308
1 1/4/40	10	13 434 309
1 1/2/50	10	13 434 310
2/63	10	13 434 311
2 1/2/75	10	13 434 312
3/90	10	13 434 313
4/110	10	13 434 314
125	10	13 434 315
5/140	10	13 434 316
6 /160	10	13 434 317

12 to 25mm (3/8" to 1") not supplied with retaining straps.



SADDLE CLIPS

Size (inch)	Standard pack quantity	Product Code
3/8	10	03 455 101
1/2	10	03 455 102
3/4	10	03 455 103
1	10	03 455 104
1 1/4	10	03 455 105
1 1/2	10	03 455 106
2	10	03 455 107
3	10	03 455 109
4	10	03 455 110



CHAMFERING AND DE-BURRING TOOLS

Description	Product Code
16-63mm pipe inner and outer milling cutter tool	FT 55 65 12
32-160mm chamfering tool	FT 55 05 10



PIPE CUTTERS

Description	Product Code
16-63mm pipe cutter	FT 80 00 01
50-125mm pipe cutter	FT 80 00 03
16-63mm spare cutter wheel	FT 80 00 02
50-125mm spare cutter wheel	FT 80 00 04

Silicone-Free valves available upon request

Durapipe Polypropylene

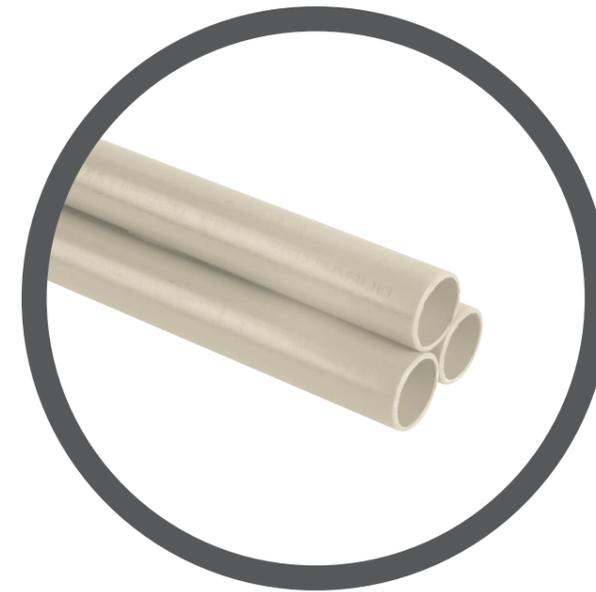

Durapipe Polypropylene

Socket Fusion – Pipe & Fittings



PIPE – PN10 system 555

Size (mm)	Standard length in metres	Product Code
20	5	35 555 306
25	5	35 555 307
32	5	35 555 308
40	5	35 555 309
50	5	35 555 310
63	5	35 555 311
75	5	35 555 312
90	5	35 555 313
110	5	35 555 314



SOCKETS – Plain 100

Size (mm)	Standard pack quantity	Product Code
20	10	35 100 306
25	10	35 100 307
32	10	35 100 308
40	5	35 100 309
50	5	35 100 310
63	2	35 100 311
75	2	35 100 312
90	2	35 100 313
110	2	35 100 314



REDUCING SOCKETS – Fusion spigot and socket 114

Size (mm)	Standard pack quantity	Product Code
25 x 20	10	35 114 415
32 x 20	10	35 114 418
32 x 25	10	35 114 419
40 x 25	10	35 114 422
40 x 32	10	35 114 423
50 x 32	10	35 114 426
50 x 40	5	35 114 427
63 x 32	10	35 114 430
63 x 50	5	35 114 432
75 x 50	5	35 114 437
75 x 63	2	35 114 438
90 x 63	2	35 114 443
90 x 75	2	35 114 444
110 x 63	2	35 114 449
110 x 90	2	35 114 451

ELBOWS 45° – Plain 119

Size (mm)	Standard pack quantity	Product Code
20	10	35 119 306
25	10	35 119 307
32	10	35 119 308
40	5	35 119 309
50	5	35 119 310
63	2	35 119 311
75	2	35 119 312
90	2	35 119 313
110	2	35 119 314



ELBOWS 90° – Plain 115

Size (mm)	Standard pack quantity	Product Code
20	10	35 115 306
25	10	35 115 307
32	10	35 115 308
40	5	35 115 309
50	5	35 115 310
63	2	35 115 311
75	2	35 115 312
90	2	35 115 313
110	2	35 115 314



TEES 90° – Equal plain 122

Size (mm)	Standard pack quantity	Product Code
20	10	35 122 306
25	10	35 122 307
32	10	35 122 308
40	5	35 122 309
50	5	35 122 310
63	2	35 122 311
75	2	35 122 312
90	2	35 122 313
110	2	35 122 314



SOCKET UNIONS – Plain 304/305

Size (mm)	Standard pack quantity	Product Code
Plain with FKM seal		
20	10	35 304 306
25	10	35 304 307
32	10	35 304 308
40	2	35 304 309
50	2	35 304 310
63	2	35 304 311
Plain with EPDM seal		
20	10	35 305 306
25	10	35 305 307
32	10	35 305 308
40	2	35 305 309
50	2	35 305 310
63	2	35 305 311



END CAPS – plain 140

Size (mm)	Standard pack quantity	Product Code
20	10	35 140 306
25	10	35 140 307
32	10	35 140 308
40	10	35 140 309
50	5	35 140 310
63	2	35 140 311
75	2	35 140 312
90	2	35 140 313
110	2	35 140 314

Durapipe Polypropylene

Socket Fusion – Fittings



HOSE ADAPTORS 158

Size (mm)	Standard pack quantity	Product Code
20 x 22 x 20	10	35 158 306
25 x 27 x 25	10	35 158 307
32 x 32 x 30	10	35 158 308
40 x 42 x 40	5	35 158 309
50 x 52 x 50	5	35 158 310
63 x 64 x 60	5	35 158 311



SOCKET UNIONS – Plain/female BSP thread 301/302

Size (mm x inch)	Standard pack quantity	Product Code
FKM seal		
20 x 1/2	10	35 301 306
25 x 3/4	10	35 301 307
32 x 1	10	35 301 308
40 x 1 1/4	2	35 301 309
50 x 1 1/2	2	35 301 310
63 x 2	2	35 301 311
EPDM seal		
20 x 1/2	10	35 302 306
25 x 3/4	10	35 302 307
32 x 1	10	35 302 308
40 x 1 1/4	2	35 302 309
50 x 1 1/2	2	35 302 310
63 x 2	2	35 302 311



SOCKETS – Plain/female BSP thread 103

Size (mm x inch)	Standard pack quantity	Product Code
20 x 1/2	10	35 103 306
25 x 3/4	10	35 103 307
32 x 1	10	35 103 308
40 x 1 1/4	5	35 103 309
50 x 1 1/2	5	35 103 310
63 x 2	2	35 103 311



MALE THREADED ADAPTORS (KBFM) – Plain spigot/male thread 151

Size (mm x inch)	Standard pack qty	Pressure rating	Product Code
20 x 1/2*	1	PN10	18 151 334
25 x 3/4*	1	PN10	18 151 336
32 x 1*	1	PN10	18 151 338
40 x 1 1/4*	1	PN10	18 151 340
50 x 1 1/2*	1	PN10	18 151 342
63 x 2*	1	PN10	18 151 343

* Made to Order (Please refer to our Terms & Conditions).



IMPERIAL/METRIC SOCKET ADAPTORS – PLAIN 345

Size (mm x inch)	Standard pack quantity	Product Code
20 x 1/2	10	35 345 306
25 x 3/4	10	35 345 307
32 x 1	10	35 345 308
40 x 1 1/4	10	35 345 309
50 x 1 1/2	5	35 345 310
63 x 2	2	35 345 311



FLANGES STUB – Plain/serrated face 135

Size (mm)	Standard pack quantity	Product Code
20	10	35 135 306
25	10	35 135 307
32	10	35 135 308
40	5	35 135 309
50	5	35 135 310
63	2	35 135 311
75	2	35 135 312
90	2	35 135 313
110	2	35 135 314



PP/FRP STEEL CORE BACKING RINGS – DIN2501 drilled to PN10/16 (compatible with BS EN 1092-1) 421

Size (mm)	Standard pack quantity	Product Code
20*	1	18 421 306
25*	1	18 421 307
32*	1	18 421 308
40*	1	18 421 309
50*	1	18 421 310
63*	1	18 421 311
75*	1	18 421 312
90*	1	18 421 313
110*	1	18 421 314

* Made to Order (Please refer to our Terms & Conditions).



PP/FRP STEEL CORE BACKING RINGS – ANSI drilled 448

Size (mm)	Standard pack quantity	Product Code
20*	1	18 448 306
25*	1	18 448 307
32*	1	18 448 308
40*	1	18 448 309
50*	1	18 448 310
63*	1	18 448 311
75*	1	18 448 312
90*	1	18 448 313

* Made to Order (Please refer to our Terms & Conditions).

Durapipe Polypropylene

Socket Fusion – Fittings



GASKETS FLAT- Stub flange EPDM/ FKM 432/411

Size (mm)	Standard pack quantity	Product Code
EPDM		
20	10	13 411 306
25	10	13 411 307
32	10	13 411 308
40	10	13 411 309
50	10	13 411 310
63	10	13 411 311
75	10	13 411 312
90	10	13 411 313
110	10	13 411 314
FKM		
20	10	23 432 306
25	10	23 432 307
32	10	23 432 308
40	10	23 432 309
50	10	23 432 310
63	10	23 432 311
75	10	23 432 312
90	10	23 432 313
110	10	23 432 314

Durapipe Polypropylene

Butt Fusion – Pipe



PIPE 550/555

Size (mm)	Standard length (m)	Product Code (PN6)	Product Code (PN10)
20	5	-	35 555 306
25	5	-	35 555 307
32	5	-	35 555 308
40	5	-	35 555 309
50	5	-	35 555 310
63	5	-	35 555 311
75	5	-	35 555 312
90	5	-	35 555 313
110	5	-	35 555 314
125*	5	17 550 315	35 555 315
140*	5	17 550 316	35 555 316
160*	5	17 550 317	35 555 317
200*	5	17 550 318	35 555 318
225*	5	17 550 319	35 555 319
250*	5	17 550 320	35 555 320
280*	5	17 550 321	35 555 321
315*	5	17 550 323	35 555 323
355*	5	17 550 324	35 555 324
400*	5	17 550 325	35 555 325

* Made to Order (Please refer to our Terms & Conditions).



PP ELECTROFUSION WELDING - couplers 40V

Size (mm)	Standard pack qty	Pressure rating	Product Code
20*	1	PN10	18 100 306
25*	1	PN10	18 100 307
32*	1	PN10	18 100 308
40*	1	PN10	18 100 309
50*	1	PN10	18 100 310
63*	1	PN10	18 100 311
75*	1	PN10	18 100 312
90*	1	PN10	18 100 313
110*	1	PN10	18 100 314
125*	1	PN10	18 100 315
140*	1	PN10	18 100 316
160*	1	PN10	18 100 317
200*	1	PN10	18 100 318
225*	1	PN10	18 100 319
250*	1	PN10	18 100 320
280*	1	PN10	18 100 321
315*	1	PN10	18 100 323
355*	1	PN6	18 100 324
400*	1	PN6	18 100 325

* Made to Order (Please refer to our Terms & Conditions).

The electrofusion couplers can be used with either socket or butt weld system but can only be used for connecting straight lengths of pipe.

Durapipe Polypropylene

Butt Fusion – Fittings



ELBOWS 90° (GBM) 115

Size (mm)	Standard pack qty	Product Code (PN6)	Product Code (PN10)
20*	10	-	18 115 306
25*	10	-	18 115 307
32*	10	-	18 115 308
40*	5	17 115 309	18 115 309
50*	5	17 115 310	18 115 310
63*	5	17 115 311	18 115 311
75*	5	17 115 312	18 115 312
90*	5	17 115 313	18 115 313
110*	5	17 115 314	18 115 314
125*	1	17 115 315	18 115 315
140*	1	17 115 316	18 115 316
160*	1	17 115 317	18 115 317
200*	1	17 115 318	18 115 318
225*	1	17 115 319	18 115 319
250*	1	17 115 320	18 115 320
280*	1	17 115 321	18 115 321
315*	1	17 115 323	18 115 323
355*	1	17 115 324	18 115 324
400*	1	17 115 325	18 115 325

* Made to Order (Please refer to our Terms & Conditions).



ELBOWS 45° (HBM) 119

Size (mm)	Standard pack qty	Product Code (PN6)	Product Code (PN10)
20*	10	-	18 119 306
25*	10	-	18 119 307
32*	10	-	18 119 308
40*	5	-	18 119 309
50*	5	-	18 119 310
63*	5	17 119 311	18 119 311
75*	5	17 119 312	18 119 312
90*	5	17 119 313	18 119 313
110*	5	17 119 314	18 119 314
125*	1	17 119 315	18 119 315
140*	1	17 119 316	18 119 316
160*	1	17 119 317	18 119 317
200*	1	17 119 318	18 119 318
225*	1	17 119 323	18 119 323

* Made to Order (Please refer to our Terms & Conditions).



TEES 90° EQUAL (TBM) 132

Size (mm)	Standard pack qty	Product Code (PN6)	Product Code (PN10)
20*	10	-	18 122 306
25*	10	-	18 122 307
32*	10	-	18 122 308
40*	5	17 122 309	18 122 309
50*	5	17 122 310	18 122 310
63*	5	17 122 311	18 122 311
75*	5	17 122 312	18 122 312
90*	5	17 122 313	18 122 313
110*	5	17 122 314	18 122 314
125*	1	17 122 315	18 122 315
140*	1	17 122 316	18 122 316
160*	1	17 122 317	18 122 317
200*	1	17 122 318	18 122 318
225*	1	17 122 319	18 122 319
250*	1	17 122 320	18 122 320
280*	1	17 122 321	18 122 321
315*	1	17 122 323	18 122 323
355*	1	17 122 324	18 122 324
400*	1	17 122 325	18 122 325

* Made to Order (Please refer to our Terms & Conditions).



FLANGES STUB (QBM) 135

Size (mm)	Standard pack qty	Product Code (PN6)	Product Code (PN10)
20*	10	-	18 135 306
25*	10	-	18 135 307
32*	10	-	18 135 308
40*	5	17 135 309	18 135 309
50*	5	17 135 310	18 135 310
63*	5	17 135 311	18 135 311
75*	5	17 135 312	18 135 312
90*	5	17 135 313	18 135 313
110*	5	17 135 314	18 135 314
125*	1	17 135 315	18 135 315
140*	1	17 135 316	18 135 316
160*	1	17 135 317	18 135 317
200*	1	17 135 318	18 135 318
225*	1	17 135 319	18 135 319
250*	1	17 135 320	18 135 320
280*	1	17 135 321	18 135 321
315*	1	17 135 323	18 135 323
355*	1	17 135 324	18 135 324
400*	1	17 135 325	18 135 325

* Made to Order (Please refer to our Terms & Conditions).

Durapipe Polypropylene

Butt Fusion – Fittings



END CAPS LONG (CBM) 149

Size (mm)	Standard pack qty	Product Code (PN6)	Product Code (PN10)
20*	10	-	18 149 306
25*	10	-	18 149 307
32*	10	-	18 149 308
40*	5	-	18 149 309
50*	5	-	18 149 310
63*	5	17 149 311	18 149 311
75*	5	17 149 312	18 149 312
90*	5	17 149 313	18 149 313
110*	5	17 149 314	18 149 314
125*	1	17 149 315	18 149 315
140*	1	17 149 316	18 149 316
160*	1	17 149 317	18 149 317
200*	1	17 149 318	18 149 318
225*	1	17 149 319	18 149 319
250*	1	17 135 320	18 135 320
280*	1	17 135 321	18 135 321
315*	1	17 135 323	18 135 323
355*	1	17 135 324	18 135 324
400*	1	17 135 325	18 135 325

* Made to Order (Please refer to our Terms & Conditions).



REDUCED TEES 90° (TRBM) 124

Size (mm)	Standard pack qty	Product Code (PN6)	Product Code (PN10)
63 x 50*	1	17 124 432	18 124 432
75 x 32*	1	-	18 124 435
75 x 50*	1	17 124 437	18 124 437
75 x 63*	1	17 124 438	18 124 438
90 x 50*	1	-	18 124 442
90 x 63*	1	17 124 443	18 124 443
90 x 75*	1	17 124 444	18 124 444
110 x 32*	1	-	18 124 446
110 x 50*	1	-	18 124 448
110 x 63*	1	17 124 449	18 124 449
110 x 75*	1	17 124 450	18 124 450
110 x 90*	1	17 124 451	18 124 451
125 x 63*	1	17 124 456	18 124 456
125 x 110*	1	17 124 459	18 124 459
140 x 63*	1	17 124 463	18 124 463
140 x 75*	1	17 124 464	18 124 464
140 x 90*	1	17 124 465	18 124 465
140 x 110*	1	17 124 466	18 124 466
160 x 63*	1	17 124 471	18 124 471
160 x 75*	1	17 124 472	18 124 472
160 x 90*	1	17 124 473	18 124 473
160 x 110*	1	17 124 474	18 124 474
160 x 125*	1	17 124 475	18 124 475
200 x 63*	1	17 124 481	18 124 481
200 x 90*	1	17 124 483	18 124 483
200 x 110*	1	17 124 484	18 124 484
200 x 125*	1	17 124 485	18 124 485
200 x 160*	1	17 124 487	18 124 487
225 x 75*	1	17 124 490	18 124 490
225 x 90*	1	17 124 491	18 124 491
225 x 110*	1	17 124 492	18 124 492
225 x 125*	1	17 124 493	18 124 493
225 x 160*	1	17 124 495	18 124 495
250 x 160*	1	17 124 497	18 124 497

* Made to Order (Please refer to our Terms & Conditions).



CONCENTRIC REDUCERS (RBM) 109

Size (mm)	Standard pack qty	Product Code (PN6)	Product Code (PN10)
25 x 20	10	-	18 109 415
32 x 20	10	-	18 109 418
32 x 25	10	-	18 109 419
40 x 20*	5	17 109 421	18 109 421
40 x 25*	5	17 109 422	18 109 422
40 x 32*	5	17 109 423	18 109 423
50 x 25*	5	17 109 425	18 109 425
50 x 32*	5	17 109 426	18 109 426
50 x 40*	5	17 109 427	18 109 427
63 x 32*	5	17 109 430	18 109 430
63 x 40*	5	17 109 431	18 109 431
63 x 50*	5	17 109 432	18 109 432
75 x 32*	1	17 109 435	18 109 435
75 x 40*	1	17 109 436	18 109 436
75 x 50*	1	17 109 437	18 109 437
75 x 63*	1	17 109 438	18 109 438
90 x 50*	1	17 109 442	18 109 442
90 x 63*	1	17 109 443	18 109 443
90 x 75*	1	17 109 444	18 109 444
110 x 50*	1	17 109 448	18 109 448
110 x 63*	1	17 109 449	18 109 449
110 x 75*	1	17 109 450	18 109 450
110 x 90*	1	17 109 451	18 109 451
125 x 63*	1	17 109 456	18 109 456
125 x 75*	1	17 109 457	18 109 457
125 x 90*	1	17 109 458	18 109 458
125 x 110*	1	17 109 459	18 109 459
140 x 75*	1	17 109 464	18 109 464
140 x 90*	1	17 109 465	18 109 465
140 x 110*	1	17 109 466	18 109 466
140 x 125*	1	17 109 467	18 109 467
160 x 90*	1	17 109 473	18 109 473
160 x 110*	1	17 109 474	18 109 474
160 x 125*	1	17 109 475	18 109 475
160 x 140*	1	17 109 476	18 109 476
200 x 140*	1	17 109 486	18 109 486
200 x 160*	1	17 109 487	18 109 487

Size (mm)	Standard pack qty	Product Code (PN6)	Product Code (PN10)
225 x 140*	1	17 109 494	18 109 494
225 x 160*	1	17 109 495	18 109 495
225 x 200*	1	17 109 496	18 109 496
250 x 160*	1	17 109 497	18 109 497
250 x 200*	1	17 109 498	18 109 498
250 x 225*	1	17 109 499	18 109 499
315 x 200*	1	17 109 510	-
315 x 225*	1	17 109 502	18 109 502
355 x 200*	1	17 109 513	18 109 513
355 x 225*	1	17 109 514	18 109 514
355 x 250*	1	17 109 515	18 109 515
355 x 280*	1	17 109 516	-
355 x 315*	1	17 109 517	18 109 517
400 x 225*	1	17 109 519	18 109 519
400 x 250*	1	17 109 520	18 109 520
400 x 280*	1	17 109 521	-
400 x 315*	1	17 109 522	18 109 522
400 x 355*	1	17 109 523	18 109 523

* Made to Order (Please refer to our Terms & Conditions).



MALE THREADED ADAPTORS (KBFM) 151

Size (mm)	Standard pack qty	Pressure rating	Product Code
20 x 1/2**	1	PN10	18 151 334
25 x 3/4**	1	PN10	18 151 336
32 x 1**	1	PN10	18 151 338
40 x 1 1/4**	1	PN10	18 151 340
50 x 1 1/2**	1	PN10	18 151 342
63 x 2**	1	PN10	18 151 343

* Made to Order (Please refer to our Terms & Conditions).

Durapipe Polypropylene

Butt Fusion – Fittings



FEMALE THREADED ADAPTORS (DBMM) 153

Size (mm x inch)	Standard pack qty	Pressure rating	Product Code
20 x 1/2*	1	PN10	18 153 334
25 x 1/2*	1	PN10	18 153 352
25 x 3/4*	1	PN10	18 153 336
32 x 3/4*	1	PN10	18 153 353
32 x 1*	1	PN10	18 153 338
40 x 1*	1	PN10	18 153 354
40 x 1 1/4*	1	PN10	18 153 340
50 x 1 1/4*	1	PN10	18 153 355
50 x 1 1/2*	1	PN10	18 153 342
63 x 2*	1	PN10	18 153 343
75 x 2 1/2*	1	PN10	18 153 347

* Made to Order (Please refer to our Terms & Conditions).



SOCKET UNIONS EPDM (BBM/L) 205

Size (mm)	Standard pack qty	Pressure rating	Product Code
20	1	PN10	18 205 306
25	1	PN10	18 205 307
32	1	PN10	18 205 308
40	1	PN10	18 205 309
50	1	PN10	18 205 310
63	1	PN10	18 205 311

FKM seals available in request



PP/FRP STEEL CORE BACKING RINGS - DIN2501 drilled to PN10/16 (compatible with BS EN 1092-1) 421

Size (mm)	DN	Standard pack quantity	Product Code
20*	15	1	18 421 306
25*	20	1	18 421 307
32*	25	1	18 421 308
40*	32	1	18 421 309
50*	40	1	18 421 310
63*	50	1	18 421 311
75*	65	1	18 421 312
90*	80	1	18 421 313
110*	100	1	18 421 314
125*	100	1	18 421 315
140*	125	1	18 421 316
160*	150	1	18 421 317
200**	200	1	18 421 318
225**	200	1	18 421 319
250**	250	1	18 421 320
280**	250	1	18 421 321
315**	300	1	18 421 323
355**	350	1	18 421 324
400**	400	1	18 421 325

* Made to Order (Please refer to our Terms & Conditions).

** PN10 Drilling



PP/FRP STEEL CORE BACKING RINGS - ANSI drilled 448

Size (mm)	DN	Standard pack quantity	Product Code
20*	15	1	18 448 306
25*	20	1	18 448 307
32*	25	1	18 448 308
40*	32	1	18 448 309
50*	40	1	18 448 310
63*	50	1	18 448 311
75*	65	1	18 448 312
90*	80	1	18 448 313
110*	100	1	18 448 314
160*	150	1	18 448 317
200*	200	1	18 448 318
250*	250	1	18 448 320
315*	300	1	18 448 323

* Made to Order (Please refer to our Terms & Conditions).



PP/FRP STEEL CORE BLANKING FLANGE - DIN2501 drilled to PN10/16 (compatible with BS EN 1092-1) 323

Size (mm)	DN	Standard pack quantity	Product Code
20*	15	1	18 323 306
25*	20	1	18 323 307
32*	25	1	18 323 308
40*	32	1	18 323 309
50*	40	1	18 323 310
63*	50	1	18 323 311
75*	65	1	18 323 312
90*	80	1	18 323 313
110*	100	1	18 323 314
125*	100	1	18 323 314
140*	125	1	18 323 316
160*	150	1	18 323 317
200*	200	1	18 323 318
225*	200	1	18 323 318
250*	250	1	18 323 320
280*	250	1	18 323 320
315*	300	1	18 323 323
355*	350	1	18 323 324
400*	400	1	18 323 325

* Made to Order (Please refer to our Terms & Conditions).

Durapipe Polypropylene

Valves - Metric



VKD DOUBLE UNION BALL VALVES - Manual - EPDM seals

Size (mm)	Standard pack quantity	Product Code
20	1	HO DKN 306
25	1	HO DKN 307
32	1	HO DKN 308
40	1	HO DKN 309
50	1	HO DKN 310
63	1	HO DKN 311

*Locking handle options are available on request, please order shape Code "DLN".



VKD DOUBLE UNION BALL VALVES - Manual - FKM seals

Size (mm)	Standard pack quantity	Product Code
20	1	HO DKP 306
25	1	HO DKP 307
32	1	HO DKP 308
40	1	HO DKP 309
50	1	HO DKP 310
63	1	HO DKP 311

*Locking handle options are available on request, please order shape Code "DLP".



VKD DOUBLE UNION BALL VALVES - Manual BSP threaded - EPDM seals

Size (inch)	Standard pack quantity	Product Code
1/2	1	HO DKN B02
3/4	1	HO DKN B03
1	1	HO DKN B04
1 1/4	1	HO DKN B05
1 1/2	1	HO DKN B06
2	1	HO DKN B07

*Locking handle options are available on request, please order shape Code "DLN".



VKD DOUBLE UNION BALL VALVES - Manual BSP threaded - FKM seals

Size (inch)	Standard pack quantity	Product Code
1/2	1	HO DKP B02
3/4	1	HO DKP B03
1	1	HO DKP B04
1 1/4	1	HO DKP B05
1 1/2	1	HO DKP B06
2	1	HO DKP B07

*Locking handle options are available on request, please order shape Code "DLP".



TKD 3-WAY BALL VALVES T-PORT - Plain female ends - EPDM seals

Size (mm)	Standard pack quantity	Product Code
75	1	HO TTN 312
90	1	HO TTN 313
110	1	HO TTN 314

Lockable handle as standard.



VKD DOUBLE UNION BALL VALVES MANUAL - FKM SEALS

Size (mm)	Standard pack quantity	Product Code
75	1	HO DKP 312
90	1	HO DKP 313
110	1	HO DKP 314

Lockable handle as standard.

Lockable handle as standard.



TKD 3-WAY BALL VALVES T-PORT - Plain female ends - FKM seals

Size (mm)	Standard pack quantity	Product Code
20	1	HO TTP 306
25	1	HO TTP 307
32	1	HO TTP 308
40	1	HO TTP 309
50	1	HO TTP 310
63	1	HO TTP 311

*Locking handle options are available on request, please order shape Code "TLP".



TKD 3-WAY BALL VALVES L-PORT - Plain female ends - FKM seals

Size (mm)	Standard pack quantity	Product Code
20	1	HO LTP 306
25	1	HO LTP 307
32	1	HO LTP 308
40	1	HO LTP 309
50	1	HO LTP 310
63	1	HO LTP 311

*Locking handle options are available on request, please order shape Code "LLP".



DIALOCK® DIAPHRAGM VALVES MANUAL - union ended with plain female ends - EPDM seals

Size (mm)	Standard pack quantity	Product Code
20	1	HO DVN 306
25	1	HO DVN 307
32	1	HO DVN 308
40	1	HO DVN 309
50	1	HO DVN 310
63	1	HO DVN 311
75*	1	HO DVN 312

PTFE seal options are available upon requests. *75mm product is supplied with plain spigot ends



DIALOCK® DIAPHRAGM VALVES MANUAL - union ended with plain female ends - FKM seals

Size (mm)	Standard pack quantity	Product Code
20	1	HO DVP 306
25	1	HO DVP 307
32	1	HO DVP 308
40	1	HO DVP 309
50	1	HO DVP 310
63	1	HO DVP 311
75*	1	HO DVP 312

PTFE seal options are available upon requests. *75mm product is supplied with plain spigot ends



VM DIAPHRAGM VALVES MANUAL - plain spigot ends - EPDM seals

Size (mm)	Standard pack quantity	Product Code
75	1	HO VMN 412
90	1	HO VMN 413



VM DIAPHRAGM VALVES MANUAL - plain spigot ends - FKM seals

Size (mm)	Standard pack quantity	Product Code
75	1	HO VMP 412
90	1	HO VMP 413



FK BUTTERFLY VALVES - Glass reinforced Polypropylene with PP disc, EPDM liner. Lever operated

Size (mm)	Standard pack quantity	Product Code
50	1	HO FKN 106
63	1	HO FKN 107
75	1	HO FKN 108
90	1	HO FKN 109
110	1	HO FKN 110
140	1	HO FKN 111
160	1	HO FKN 112
225	1	HO FKN 113



FK BUTTERFLY VALVES - Glass reinforced Polypropylene with PP disc, FKM liner. Lever operated

Size (mm)	Standard pack quantity	Product Code
50	1	HO FKP 106
63	1	HO FKP 107
75	1	HO FKP 108
90	1	HO FKP 109
110	1	HO FKP 110
140	1	HO FKP 111
160	1	HO FKP 112
225	1	HO FKP 113

Durapipe Polypropylene

Valves – Metric



FK BUTTERFLY VALVES – With gear box, EPDM liner

Size (mm)	Standard pack quantity	Product Code
280	1	HV FKN 114
315	1	HV FKN 115



RV Y-TYPE STRAINERS – Socket union ends – EPDM seals

Size (mm)	Standard pack quantity	Product Code
20	1	HO UVN 306
25	1	HO UVN 307
32	1	HO UVN 308
40	1	HO UVN 309
50	1	HO UVN 310
63	1	HO UVN 311



VKR METERING BALL VALVE – Plain Female Ends – EPDM seals

Size (mm)	Standard pack quantity	Product Code
16	1	HO MBN 305
20	1	HO MBN 306
25	1	HO MBN 307
32	1	HO MBN 308
40	1	HO MBN 309
50	1	HO MBN 310
63	1	HO MBN 311



FK BUTTERFLY VALVES – With gear box, FKM liner

Size (mm)	Standard pack quantity	Product Code
280	1	HV FKP 114
315	1	HV FKP 115



RV Y-TYPE STRAINERS – Socket union ends – FKM seals

Size (mm)	Standard pack quantity	Product Code
20	1	HO UVP 306
25	1	HO UVP 307
32	1	HO UVP 308
40	1	HO UVP 309
50	1	HO UVP 310
63	1	HO UVP 311



VKR METERING BALL VALVE – Plain Female Ends – FKM seals

Size (mm)	Standard pack quantity	Product Code
16	1	HO MBP 305
20	1	HO MBP 306
25	1	HO MBP 307
32	1	HO MBP 308
40	1	HO MBP 309
50	1	HO MBP 310
63	1	HO MBP 311



SR BALL CHECK VALVE – Socket union ends – EPDM seals

Size (mm)	Standard pack quantity	Product Code
20*	1	HO SRN 306
25*	1	HO SRN 307
32*	1	HO SRN 308
40*	1	HO SRN 309
50*	1	HO SRN 310
63*	1	HO SRN 311

* Made to Order (Please refer to our Terms & Conditions).



SR BALL CHECK VALVE – Socket union ends – FKM seals

Size (mm)	Standard pack quantity	Product Code
20*	1	HO SRP 306
25*	1	HO SRP 307
32*	1	HO SRP 308
40*	1	HO SRP 309
50*	1	HO SRP 310
63*	1	HO SRP 311

* Made to Order (Please refer to our Terms & Conditions).



UR ANGLE SEAT CHECK VALVES – Socket union ends – EPDM seals

Size (mm)	Standard pack quantity	Product Code
20	1	HO URN 306
25	1	HO URN 307
32	1	HO URN 308
40	1	HO URN 309
50	1	HO URN 310
63	1	HO URN 311

Note: This valve must be installed at a minimum distance of 10 x nominal diameter (eg. 20" for size 2") from pump flange.



UR ANGLE SEAT CHECK VALVES – Socket union ends – FKM seals

Size (mm)	Standard pack quantity	Product Code
20	1	HO URP 306
25	1	HO URP 307
32	1	HO URP 308
40	1	HO URP 309
50	1	HO URP 310
63	1	HO URP 311

Note: This valve must be installed at a minimum distance of 10 x nominal diameter (eg. 20" for size 2") from pump flange.

Durapipe Polypropylene

Accessories



ECO CLEANER 457

Contents	Standard pack quantity	Product Code
½ litre	12	03 457 395



COBRA PIPE CLIPS 434

Size (mm)	Standard pack quantity	Product Code
16	10	13 434 305
20	10	13 434 306
25	10	13 434 307
32	10	13 434 308
40	10	13 434 309
50	10	13 434 310
63	10	13 434 311
75	10	13 434 312
90	10	13 434 313
110	10	13 434 314
125	10	13 434 315
140	10	13 434 316
160	10	13 434 317

16 to 25mm clips not supplied with retaining straps.



SADDLE CLIPS 455

Size (inch/mm)	Standard pack quantity	Product Code
¾/16	10	03 455 101
½/20	10	03 455 102
¾/25	10	03 455 103
1/32	10	03 455 104
1¼/40	10	03 455 105
1½/50	10	03 455 106
2/63	10	03 455 107
3/90	10	03 455 109
4/110	10	03 455 110

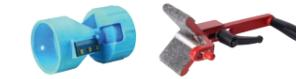

CHAMFERING AND DE-BURRING TOOLS

Description	Product Code
16–63mm pipe inner and outer milling cutter tool	FT 55 65 12
32–160mm chamfering tool	FT 55 05 10



PIPE CUTTERS

Description	Product Code
16–63mm pipe cutter	FT 80 00 01
50–125mm pipe cutter	FT 80 00 03
16–63mm spare cutter wheel	FT 80 00 02
50–125mm spare cutter wheel	FT 80 00 04

Actuated Valves available

For **Actuated valves** please visit our Actuation section on **pages 122–130**

PLX



PLX

Single wall pipework system for fuel



SINGLE WALL PIPE - SDR11 - 10bar

Size (mm)	Standard length	Product Code
32*	Straights 6m	43 626 308
50	Straights 6m	43 626 310
63	Straights 6m	43 626 311
90	Straights 6m	43 626 313
110	Straights 6m	43 626 314
160*	Straights 6m	43 626 317
220*	Straights 6m	43 626 320
315*	Straights 6m	43 626 323

* Made to Order (Please refer to our Terms & Conditions).



SINGLE WALL PIPE - SDR11 - 10bar

Size (mm)	Standard length	Product Code
32	Coils 50m	43 614 308
50	Coils 50m	43 614 310
63	Coils 50m	43 614 311
32	Coils 100m	43 615 308
50	Coils 100m	43 615 310
63	Coils 100m	43 615 311



SINGLE WALL PIPE - SDR17 - 6bar

Size (mm)	Standard length	Product Code
63	Straights 6m	43 609 311
90	Straights 6m	43 609 313
110	Straights 6m	43 609 314



SINGLE WALL COUPLERS - 39.5V - 10bar

Size (mm)	Standard pack quantity	Product Code
32	1	43 100 308
50	1	43 100 310
63	1	43 100 311
90	1	43 100 313
110	1	43 100 314
160*	1	43 100 317
225*	1	43 100 320
315*	1	43 100 323

* Made to Order (Please refer to our Terms & Conditions).



SINGLE WALL ELBOWS 45° - 39.5V - 10bar

Size (mm)	Standard pack quantity	Product Code
32	1	43 105 308
50	1	43 105 310
63	1	43 105 311
90	1	43 105 313
110	1	43 105 314
160*	1	43 105 317
225*	1	43 105 320
315*	1	43 105 323

* Made to Order (Please refer to our Terms & Conditions).



SINGLE WALL ELBOWS 90° - 39.5V - 10bar

Size (mm)	Standard pack quantity	Product Code
32	1	43 104 308
50	1	43 104 310
63	1	43 104 311
90	1	43 104 313
110	1	43 104 314
160*	1	43 104 317
225*	1	43 104 320
315*	1	43 104 323

* Made to Order (Please refer to our Terms & Conditions).



SINGLE WALL EQUAL TEE (SPIGOT BRANCH) - 39.5V - 10bar

Size (mm)	Standard pack quantity	Product Code
32	1	43 408 308
50	1	43 408 310
63	1	43 408 311
90	1	43 408 313
110	1	43 408 314



SINGLE WALL EQUAL 3-WAY EF TEE - 39.5V - 10bar

Size (mm)	Standard pack quantity	Product Code
160	1	43 410 317
225	1	43 410 320
315	1	43 410 323

Product supplied with 4.0mm terminal pins.



SINGLE WALL REDUCER - 39.5V - 10bar

Size (mm)	Standard pack quantity	Product Code
32x50	1	43 402 414
32x63	1	43 402 415
50x63	1	43 402 444
63x63	1	43 402 459
90x110	1	43 402 483
110x160	1	43 402 495

Product supplied with 4.0mm terminal pins.



SINGLE WALL END CAPS - SDR11 - 39.5V - 10bar

Size (mm)	Standard pack quantity	Product Code
32	1	43 233 308
50	1	43 233 310
63	1	43 233 311

PLX

Single wall pipework system for fuel



SINGLE WALL END CAPS - SDR17 - 39.5V - 6bar

Size (mm)	Standard pack quantity	Product Code
90	1	43 232 313
110	1	43 232 314



SINGLE WALL EF END CAP - SDR11 - 39.5V - PN10

Size (mm)	Standard pack quantity	Product Code
32mm	1	43 235 308
50mm	1	43 235 310
63mm	1	43 235 311
90mm	1	43 235 313
110mm	1	43 235 314

Supplied with 4.0mm terminal pins



SINGLE WALL EF FEMALE BSP - 39.5V - 10bar

Size (mm)	Standard pack quantity	Product Code
32 x 1"	1	43 394 308
50 x 1 1/2"	1	43 741 310
63 x 1 1/2"	1	43 741 628
90 x 3"	1	43 483 313
63 x 2"	1	43 741 311



SINGLE WALL EF MALE BSP - 39.5V - 10bar

Size (mm)	Standard pack quantity	Product Code
32 x 1"	1	43 395 308
50 x 1 1/2"	1	43 743 310
63 x 1 1/2"	1	43 743 628
63 x 2"	1	43 743 311



SINGLE WALL EF FEMALE BSP - 39.5V - 10bar

Size (mm)	Standard pack quantity	Product Code
50 x 1 1/2"	1	43 742 310
63 x 2"	1	43 742 311



SINGLE WALL SPIGOT FEMALE BSP - 10bar

Size (mm)	Standard pack quantity	Product Code
50 x 1 1/2"	1	43 719 310
63 x 1 1/2"	1	43 719 628
63 x 2"	1	43 719 311
90 x 3"	1	43 483 313
110 x 4"	1	43 483 314



SINGLE WALL SPIGOT MALE BSP - 10bar

Size (mm)	Standard pack quantity	Product Code
50 x 1 1/2"	1	43 723 310
63 x 1 1/2"	1	43 723 628
63 x 2"	1	43 723 311
90 x 3"	1	43 480 313
110 x 4"	1	43 480 314



SINGLE WALL SPIGOT FEMALE COMPACT - Flange BSP - 10bar

Size (mm)	Standard pack quantity	Product Code
50 x 1 1/2"	1	43 721 310
63 x 2"	1	43 721 311
90 x 3"	1	43 484 313
110 x 4"	1	43 484 314



SINGLE WALL LONG SPIGOT FEMALE - Extended BSP - 10bar

Size (mm)	Standard pack quantity	Product Code
50 x 1 1/2"	1	43 481 310
63 x 1 1/2"	1	43 481 628
63 x 2"	1	43 481 311



SINGLE WALL LONG SPIGOT FEMALE - Extended BSP - 10bar

Size (mm)	Standard pack quantity	Product Code
90 x 3"	1	43 735 313
110 x 4"	1	43 735 314



SINGLE WALL LONG SPIGOT FEMALE COMPACT FLANGE EXTENDED BSP - 6bar (also Fill & Vent)

Size (mm)	Standard pack quantity	Product Code
50 x 1 1/2"	1	43 482 310
63 x 2"	1	43 482 311
90 x 3"	1	43 736 313
110 x 4"	1	43 736 314



SINGLE WALL SDR11 PE STUB - Flange Assembly - 10bar

Size (mm)	Standard pack quantity	Product Code
50 (40NW)	1	43 329 310
63 (50NW)	1	43 329 311
90 (80NW)	1	43 329 313
110 (100NW)	1	43 329 314
160 (150NW)*	1	43 329 317
225 (200NW)*	1	43 329 320
315 (300NW)*	1	43 329 323

* Made to Order (Please refer to our Terms & Conditions).

PLX

Close-Fit secondary contained system for fuel



CLOSE-FIT PIPE SDR11#26 - STRAIGHTS - 10bar Primary, 4bar Secondary

Size (mm)	Standard length	Product Code
32#40	Straights - 6m	43 664 413
50#63	Straights - 6m	43 664 444
63#75	Straights - 6m	43 664 445
90#110	Straights - 6m	43 664 446
110#125	Straights - 6m	43 664 447



CLOSE-FIT PIPE SDR11#26 - COILS - 10bar Primary, 4bar Secondary

Size (mm)	Standard length	Product Code
32#40	Coils - 50m	43 624 413
50#63	Coils - 50m	43 624 444
63#75	Coils - 50m	43 624 445
32#40	Coils - 100m	43 649 413
50#63	Coils - 100m	43 649 444
63#75	Coils - 100m	43 649 445

Secondary Contained Options available in larger sizes upon request, please contact our technical team for further information technical@durapipe.co.uk



CLOSE-FIT GRAVITY FILL & VENT PIPE SDR17#26 - STRAIGHTS - 6bar Primary, 4bar Secondary

Size (mm)	Standard length	Product Code
90#110	Straights - 6m	43 665 446
110#125	Straights - 6m	43 665 447



CLOSE-FIT PIPE JOINER KIT - 39.5v - 10bar

Size (mm)	Standard pack quantity	Product Code
32#40	1	43 249 308
50#63	1	43 249 310
63#75	1	43 249 311
90#110	1	43 249 313
110#125	1	43 249 314



ONE-WELD SECONDARY CONTAINED COUPLER - 39.5v - 10bar

Size (mm)	Standard pack quantity	Product Code
63#75	1	43 100 445
110#125	1	43 100 447



CLOSE-FIT REDUCER KIT- 39.5v - 10bar Primary, 4bar Secondary

Size (mm)	Standard pack quantity	Product Code
32#40 x 50#63	1	43 343 308
32#40 x 63#75	1	43 343 368
50#63 x 63#75	1	43 343 310
63#75 x 90#110	1	43 343 311
63#75 x 110#125	1	43 343 361
90#110 x 110#125	1	43 343 313

* Supplied as a reducer kit



SECONDARY CONTAINED 45° ELBOW - 39.5v - 10bar*

System size (mm)	Size (mm)	Pack qty	Product Code	Closure fittings
32#40	32#63	1	43 250 308	2 x 43 278 430
50#63	50#90	1	43 250 310	2 x 43 278 459
63#75	63#110	1	43 250 311	2 x 43 278 472
90#110	90#160	1	43 262 313	2 x 43 278 475
110#125	110#160	1	43 262 314	2 x 43 278 476

(2 no. closures required to complete Close-Fit)



SECONDARY CONTAINED 90° ELBOW - 39.5v - 10bar*

System size (mm)	Size (mm)	Pack qty	Product Code	Closure fittings
32#40	32#63	1	43 248 308	2 x 43 278 430
50#63	50#90	1	43 248 310	2 x 43 278 459
63#75	63#110	1	43 248 311	2 x 43 278 472
90#110	90#160	1	43 263 313	2 x 43 278 475
110#125	110#160	1	43 263 314	2 x 43 278 476

(2 no. closures required to complete Close-Fit)



ONE-WELD SECONDARY CONTAINED 90° ELBOW - 39.5v - 10bar

Size (mm)	Standard pack quantity	Product Code
63#75	1	43 104 445
110#125	1	43 104 447



CLOSE-FIT SPIGOT HOCKEY STICK SDR11#26 - 10bar Primary, 4bar Secondary

System size (mm)	Size (mm)	Pack quantity	Product Code
32#40*	32#40	1	43 338 308

* Made to Order (Please refer to our Terms & Conditions).

PLX

Close-Fit secondary contained system for fuel



SECONDARY CONTAINED EQUAL TEE - 39.5v - 10bar*

System size (mm)	Size (mm)	Pack qty	Product Code	Closure fittings
32#40	32#63	1	43 246 308	3 x 43 278 430
50#63	50#90	1	43 246 310	3 x 43 278 459
63#75	63#110	1	43 246 311	3 x 43 278 472
90#110	90#160	1	43 347 313	3 x 43 278 475
110#125	110#160	1	43 347 314	3 x 43 278 476

3 x PLX closure fittings required to connect with PLX close fit pipework.



SECONDARY CONTAINED REDUCING TEE - 39.5v - 10bar

System size (mm)	Size (mm)	Pack qty	Product Code
90#110	90#160 (63#110)	1	43 720 313
110#160	110#160 (63#110)	1	43 720 314

3 x PLX Closure fittings required to connect with close fit pipework.



SECONDARY CONTAINED SLIP CLOSURE - 39.5v - 4bar

Size (mm)	Standard pack quantity	Product Code
32#40	1	43 278 413
40#63	1	43 278 430
50#63	1	43 278 444
63#75	1	43 278 445
63#90	1	43 278 459
75#110	1	43 278 472
90#110	1	43 278 473
110#125	1	43 278 474
110#160	1	43 278 475
125#160	1	43 278 476



SECONDARY CONTAINED SLIP CLOSURE - with 1/8" BSP Access Port 39.5v - 4bar

Size (mm)	Standard pack quantity	Product Code
32#40	1	43 279 413
40#63	1	43 279 430
50#63	1	43 279 444
63#75	1	43 279 445
63#90	1	43 279 459
75#110	1	43 279 472
90#110	1	43 279 473
110#125	1	43 279 474
110#160	1	43 279 475
125#160	1	43 279 476



PLX CLOSE FIT ELECTROFUSION CHAMBER ENTRY FITTING

Size (mm)	Standard pack quantity	Product Code
63#75	1	43 470 445

Designed to connect PLX secondary contained close fit pipework into a polyethylene chamber.



CLOSE-FIT EF FEMALE BSP - 39.5v - 10bar*

Size (mm)	Standard pack quantity	Product Code
32#40 x 1"	1	43 749 413
50#63 x 1 1/2"	1	43 749 444
63#75 x 2"	1	43 749 445



CLOSE-FIT EF FEMALE BSP WITH 1/8" BSP ACCESS PORT - 39.5v - 10bar*

Size (mm)	Pack quantity	Product Code
32#40 x 1"	1	43 750 413
50#63 x 1 1/2"	1	43 750 444
63#75 x 2"	1	43 750 445



SINGLE WALL EF FEMALE COMPACT FLANGE BSP - 39.5v - 10bar*

System Size (mm)	Pack quantity	Product Code	Closures Required
50 x 1 1/2"	1	43 742 310	1 x 43 278 444
63x 2"	1	43 742 311	1 x 43 278 445

(1 no. closure required to complete Close-Fit transition).



SINGLE WALL SPIGOT FEMALE COMPACT FLANGE BSP - 10bar

System Size (mm)	Pack quantity	Product Code	Closures Required
50 x 1 1/2"	1	43 721 310	1 x 43 278 444
63x 2"	1	43 721 311	1 x 43 278 445
90x 3"	1	43 484 313	1 x 43 278 473
110x 4"	1	43 484 314	1 x 43 278 474

(1 no. closure required to complete Close-Fit transition).

* Please note that although the fitting is 10bar rated, when used in conjunction with a SDR17 6bar pipe this will result in a 6bar system.

* Please note that although the fitting is 10bar rated, when used in conjunction with a SDR17 6bar pipe this will result in a 6bar system.

PLX

Close-Fit secondary contained system for fuel



SINGLE WALL SDR11 PE STUB - Flange Assembly - 10bar

Size (mm)	Standard pack quantity	Product Code
50 (40NW)	1	43 329 310
63 (50NW)	1	43 329 311
90 (80NW)	1	43 329 313
110 (100NW)	1	43 329 314
160 (150NW)*	1	43 329 317
225 (200NW)*	1	43 329 320
315 (300NW)*	1	43 329 323

* Made to Order (Please refer to our Terms & Conditions).



SINGLE WALL SPIGOT FEMALE EXTENDED BSP FILL & VENT - 6bar*

System Size (mm)	Size (mm)	Pack qty	Product Code	Closures Required
90x 3'	90	1	43 735 313	1 x 43 278 473
110x 4'	110	1	43 735 314	1 x 43 278 474

(1 no. closure required to complete Close-Fit transition).



SECONDARY CONTAINED INTERSTITIAL ACCESS SADDLE - 39.5v - 10bar

Size (mm)	Standard pack quantity	Product Code
63 x 32	1	43 416 415
90 x 32	1	43 416 417
110 x 32	1	43 416 418
160 x 32	1	43 416 421



SECONDARY CONTAINED INTERSTITIAL ACCESS SADDLE WITH 1/8" ACCESS PORT - 39.5v - 6bar

Size (mm)	Standard pack quantity	Product Code
63 x x 3/8" BSP	1	43 354 311
90 x x 3/8" BSP	1	43 354 313
110 x x 3/8" BSP	1	43 354 314
160 x x 3/8" BSP	1	43 354 317



ONE-WELD SECONDARY CONTAINED ZONE FITTING - 39.5v - 10bar

Size (mm)	Standard pack quantity	Product Code
63#75	1	43 458 445
110#125	1	43 458 447

Designed to section the fuel line into two zones for leak detection monitoring

PLX Blue

PLX Blue: Specifically designed for AdBlue



PLX BLUE SINGLE WALL PIPE SDR11 STRAIGHTS - 10bar

Size (mm)	Standard length in metres	Product Code
32	6	34 626 308



PLX BLUE CLOSE-FIT PIPE SDR11#26 STRAIGHTS - 10bar Primary, 4bar Secondary

Size (mm)	Standard length in metres	Product Code
32#40	6	34 664 413



SINGLE WALL COUPLER - 39.5v - 10bar

Size (mm)	Standard pack quantity	Product Code
32	1	43 100 308



SINGLE WALL COUPLER - 39.5v - 10bar

Size (mm)	Standard pack quantity	Product Code
32	1	43 105 308



SINGLE WALL 90° ELBOW - 39.5v - 10bar

Size (mm)	Standard pack quantity	Product Code
32	1	43 104 308



SINGLE WALL EQUAL TEE (SPIGOT BRANCH) - 39.5v - 10bar

Size (mm)	Standard pack quantity	Product Code
32	1	43 408 308

Secondary Contained Fittings



CLOSE-FIT PIPE JOINER - 39.5v - 10bar

Size (mm)	Standard pack quantity	Product Code
32#40	1	43 249 308



SECONDARY CONTAINED 45° ELBOW - 39.5v - 10bar

System Size (mm)	Size (mm)	Pack qty	Product Code	Closures required
32#40	32#63	1	43 250 308	2 x 43 278 430

(2 no. slip couplers and primary couplers required to complete Pipe-in-Pipe anchor).



SECONDARY CONTAINED 45° ELBOW - 39.5v - 10bar

System Size (mm)	Size (mm)	Pack qty	Product Code	Closures required
32#40	32#63	1	43 248 308	2 x 43 278 430

(2 no. slip couplers and primary couplers required to complete Pipe-in-Pipe anchor).



SECONDARY CONTAINED EQUAL TEE - 39.5v - 10bar

System Size (mm)	Size (mm)	Pack qty	Product Code	Closures required
32#40	32#63	1	43 246 308	3 x 43 278 430

(3 no. closures required to complete Close-Fit tee).



SECONDARY CONTAINED SLIP CLOSURE - 39.5v - 4bar

Size (mm)	Standard pack quantity	Product Code
32#40	1	43 278 413
40#63	1	43 278 430



SECONDARY CONTAINED SLIP CLOSURE WITH 1/8" BSP ACCESS PORT - 39.5v - 4bar

Size (mm)	Standard pack quantity	Product Code
32#40	1	43 279 413
40#63	1	43 279 430



SINGLE WALL EF FEMALE BSP "STAINLESS STEEL" 39.5v - 10 bar

Size (mm)	Bag quantity	Product Code
32 x 1"	1	34 394 308

1 x PLX closure fitting required to complete close fit connection.

* Please note that although the fitting is 10bar rated, when used in conjunction with a SDR17 6bar pipe this will result in a 6bar system.

PLX+

Conductive pipework for fuel



PLX+ SINGLE WALL PIPE SDR11 - Straights - 10bar

Size (mm)	Standard length in metres	Product Code
63	6	72 626 311

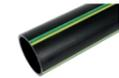

PLX+ SINGLE WALL PIPE SDR11 - Coils - 10bar

Size (mm)	Standard length	Product Code
63	100	72 615 311

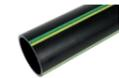

PLX+ SINGLE WALL PIPE SDR17 - Straights - 6bar

Size (mm)	Standard length in metres	Product Code
90	6	72 609 313
110	6	72 609 314

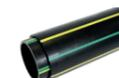

PLX+ CLOSE-FIT PIPE SDR11#26 - Straights - 10bar Primary, 4bar Secondary

Size (mm)	Standard length in metres	Product Code
63#75	6	72 664 445



PLX+ CLOSE-FIT PIPE SDR11#26 COILS - 10bar Primary, 4bar Secondary

Size (mm)	Standard length in metres	Product Code
63#75	50	72 624 445
63#75	100	72 649 445



PLX+ CLOSE-FIT GRAVITY FILL & VENT PIPE SDR17#26 - Straights - 4bar

Size (mm)	Standard length in metres	Product Code
90#110	6	72 665 446
110#125	6	72 665 447



PLX+ SINGLE WALL COUPLER - 39.5v - 10bar*

Size (mm)	Standard pack quantity	Product Code
63	1	72 100 311
90	1	72 100 313A
110	1	72 100 314A



PLX+ SINGLE WALL 45° ELBOW - 39.5v - 10bar*

Size (mm)	Standard pack quantity	Product Code
63	1	72 105 311
90	1	72 105 313A
110	1	72 105 314A



PLX+ SINGLE WALL 0° ELBOW - 39.5v - 10bar*

Size (mm)	Standard pack quantity	Product Code
63	1	72 104 311
90	1	72 104 313A
110	1	72 104 314A



PLX+ SINGLE WALL EQUAL TEE (SPIGOT BRANCH) - 39.5v - 10bar*

Size (mm)	Standard pack quantity	Product Code
63	1	72 410 311

Secondary Contained Fittings



PLX+ CLOSE-FIT PIPE JOINER - 39.5v - 10bar*

Size (mm)	Standard pack quantity	Product Code
63#75	1	72 249 311
90#110	1	72 249 313A
110#125	1	72 249 314A



PLX+ SECONDARY CONTAINED 45° ELBOW - 39.5v - 10bar*

System Size (mm)	Size (mm)	Pack qty	Product Code	Closures required
63#75	63#110	1	72 250 311	2 x 43 278 472
90#110	90#160	1	72 262 313A	2 x 43 278 475
110#125	110#160	1	72 262 314A	2 x 43 278 476

PLX+

Conductive pipework for fuel



PLX+ SECONDARY CONTAINED 90° ELBOW - 39.5v - 10bar*

System Size (mm)	Size (mm)	Pack qty	Product Code	Closures required
63#75	63#110	1	72 248 311	2 x 43 278 472
90#110	90#160	1	72 263 313A	2 x 43 278 475
110#125	110#160	1	72 263 314A	2 x 43 278 476

(2 no. closures required to complete PLX+ Close-Fit elbow).



PLX+ SECONDARY CONTAINED EQUAL TEE - 39.5v - 10bar*

System Size (mm)	Size (mm)	Pack qty	Product Code	Closures required
63#75	63#110	1	72 246 311	3 x 43 278 472

(3 no.l closures required to complete PLX+ Close-Fit tee).



SECONDARY CONTAINED SLIP CLOSURE - 39.5v - 4bar

Size (mm)	Standard pack quantity	Product Code
63#75	1	43 278 445
63#90	1	43 278 459
75#110	1	43 278 472
90#110	1	43 278 473
110#125	1	43 278 474
110#160	1	43 278 475
125#160	1	43 278 476



SECONDARY CONTAINED SLIP CLOSURE WITH 1/8" BSP ACCESS PORT - 39.5v - 4bar

Size (mm)	Standard pack quantity	Product Code
63#75	1	43 279 445
63#90	1	43 279 459
75#110	1	43 279 472
90#110	1	43 279 473
110#125	1	43 279 474
110#160	1	43 279 475
125#160	1	43 279 476



PLX+ SINGLE WALL LONG SPIGOT FEMALE EXTENDED BSP - 10bar

Size (mm)	Pack qty	Product Code	Closures Required
63 x 2"	1	72 481 311	1 x 43 278 445



PLX+ SINGLE WALL LONG SPIGOT FEMALE EXTENDED BSP FILL & VENT - 6bar

Size (mm)	Pack qty	Product Code	Closures Required
90 x 3"	1	72 735 313A	1 x 43 278 473
110 x 4"	1	72 735 314A	1 x 43 278 474



PLX+ SINGLE WALL LONG SPIGOT FEMALE COMPACT FLANGE EXTENDED BSP - 10bar

Size (mm)	Pack qty	Product Code	Closures Required
63 x 2"	1	72 482 311	1 x 43 278 445



PLX+ SINGLE WALL LONG SPIGOT FEMALE COMPACT FLANGE EXTENDED BSP - 6bar (also Fill & Vent)

Size (mm)	Pack qty	Product Code	Closures Required
90 x 3"	1	72 736 313A	1 x 43 278 473
110 x 4"	1	72 736 314A	1 x 43 278 474



PLX+ SINGLE WALL STUB FLANGE - 10bar

Size (mm)	Pack qty	Product Code	Closures Required
63 (SONW)	1	72 271 311	1 x 43 278 445



PLX+ SINGLE WALL STUB FLANGE - 6bar (also Fill & Vent)

Size (mm)	Pack qty	Product Code	Closures Required
90 (80NW)	1	72 271 313A	1 x 43 278 473
110 (100NW)	1	72 271 314A	1 x 43 278 474

* Please note that although the fitting is 10bar rated, when used in conjunction with a SDR17 6bar pipe this will result in a 6bar system.

* Please note that although the fitting is 10bar rated, when used in conjunction with a SDR17 6bar pipe this will result in a 6bar system.

PLX+

Conductive pipework for fuel transfer



PLX+ SINGLE WALL SDR11 PE STUB FLANGE ASSEMBLY - 10bar

Size (mm)	Pack qty	Product Code	Closures Required
63 (50NW)	1	72 329 311	1 x 43 278 445



PLX+ SINGLE WALL SDR17 PE STUB FLANGE ASSEMBLY - 6bar (also Fill & Vent)

Size (mm)	Pack qty	Product Code	Closures Required
90 (80NW)	1	72 328 313	1 x 43 278 445
110 (100NW)	1	72 328 314	1 x 43 278 445



PLX+ CLOSE-FIT EF FEMALE BSP - 39.5v - 10bar*

Size (mm)	Standard pack quantity	Product Code
63#75 x 2"	1	72 749 445



PLX+ CLOSE-FIT EF FEMALE BSP - 39.5v - 10bar*

Size (mm)	Standard pack quantity	Product Code
63#75 x 2"	1	72 750 445



PLX+ CONDUCTIVITY TESTER KIT
Includes: Flying leads adaptors (1 pair), hand scraper, USB data stick, 2 x cables with 90° angled connection and 4.7mm/4mm adaptors

Description	Product Code
PLX+ Conductivity Tester	72 TES 001

* Please note that although the fitting is 10bar rated, when used in conjunction with a SDR17 6bar pipe this will result in a 6bar system.

PLX One-Weld

Secondary Contained EF Fittings



4 welds within one electrofusion cycle



Saving significant installation time (average 15 minutes per fitting)



Interstitial monitoring as standard



Designed for use with PLX secondary contained close fit pipe



Manual and barcode welding options



Industry first One-Weld elbow



Interstitial monitoring

Integrated pipe measurement tool

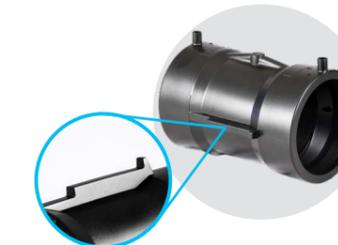

PLX

PLX Tooling

Specialist Installation/Preparation Tooling



PLX ECU WELDING MACHINES
Includes: welding machine, flying leads adaptors (1 pair), hand scraper, USB data stick, 2 x cables with 90° angled connection and 4.7mm/4mm adaptors

Description	Weight (kg)	Product Code
PLX Welding Machine Connexion Blue LightManual 110v (32mm up to 160mm)	18	43 ECU 021
PLX Welding Machine Connexion Blue LightManual 230v (32mm up to 160mm)	18	43 ECU 020
PLX Welding Machine Connexion Blue LightBarCode 110v (32mm up to 160mm)	18	43 ECU 023
PLX Welding Machine Connexion Blue LightBarCode 230v (32mm up to 160mm)	18	43 ECU 022
PLX Welding Machine Connexion Blue Manual 110v (32mm up to 450mm)	22	43 ECU 011
PLX Welding Machine Connexion Blue Manual 230v (32mm up to 450mm)	22	43 ECU 010
PLX Welding Machine Connexion Blue BarCode 110v (32mm up to 450mm)	22	43 ECU 013
PLX Welding Machine Connexion Blue BarCode 230v (32mm up to 450mm)	22	43 ECU 012



PLX LIGHTWEIGHT WELDING MACHINE
Includes: welding machine, 2 x cables, bar code reader, flying lead adapters (1pair), 4.7mm/4.0mm adapters and hand scraper.

Description	Product Code
PLX L/weight - Light Duty Case	43 LCU 010
PLX L/weight - Heavy Duty Case	43 LCU 011



PREPERATION TOOLS

Description	Product Code
PLX Pipetools SurPrep Multikit 32 - 110mm	43 MZO 018
PLX Pipetools Uniprep 1 Preparation Tool 90 - 400mm	43 MZO 020
PLX Pipetools Uniprep 4 Preparation Tool 63 - 225mm	43 MZO 019



PLX ACCESS PORT 1/8" BSP CAP - STAINLESS STEEL

Size (mm)	Pack qty	Product Code
One size	1	43 EWO 030



CLAMPS

Description	Product Code
PLX Close Fit Hand Held Pipe Clamp	43 MZO 060
PLX 32 - 63mm Pipetools Universal Pipe Clamp	43 MZO 050
PLX 63 - 160mm Pipetools Universal Pipe Clamp	43 MZO 051
PLX 125 - 400mm Pipetools Universal Pipe Clamp	43 MZO 052
PLX 32 - 40mm to 63 - 75mm Pipetools. Close-Fit Pipe Clamp	43 MZO 053



CUTTERS

Description	Product Code
PLX 32 - 63mm Pipetools Cutter	43 777 101
PLX 50 - 110mm Pipetools Cutter	43 728 100
PLX 110 - 160mm Pipetools Cutter	43 728 102
PLX 225mm Pipetools Virax Guillotine Pipe Cutter	43 728 200
PLX 315mm Pipetools Virax Guillotine Pipe Cutter	43 728 201



PROTECTION SLEEVES

Description	Product Code
PLX 50 - 63mm Pipetools Protection Sleeve	43 494 310
PLX 63 - 75mm Pipetools Protection Sleeve	43 494 311
PLX 90 - 110mm Pipetools Protection Sleeve	43 494 313
PLX 110 - 125mm Pipetools Protection Sleeve	43 494 314



WELDING ACCESSORIES

Description	Product Code
PLX ECU Storage Case	43 997 321
PLX Welding Machine Spring Adaptors (1 Pair)	43 EWO 004
PLX Weld Machine Fixed Output Lead	43 EWO 007
PLX Terminal adaptor 4.7mm male x 4.0mm female (Pair)	43 EWO 002
PLX Close Contact Bar Code Scanner	43 EWO 012
PLX Pipetools Hand Scraper	43 SPA 012
PLX Ispopropanol Wipes (Tub)	43 451 101

PLX Electrical Conduit

True external barrier conduit and fittings



PLX ELECTRICAL CONDUIT PIPE - COILS - NON-PRESSURE

Size (mm)	Standard length	Product Code
32mm	Coils - 100M	75 615 308



COMPRESSION JOINER

Size (mm)	Pack quantity	Product Code
32mm	1	75 100 308



COMPRESSION 90° ELBOW

Size (mm)	Pack quantity	Product Code
32mm	1	75 104 308



COMPRESSION PLAIN/FEMALE BSP

Size (mm)	Pack quantity	Product Code
32mm x 3/4"	1	75 394 328
32mm x 1"	1	75 394 308



COMPRESSION PLAIN/MALE BSP

Size (mm)	Pack quantity	Product Code
32mm x 3/4"	1	75 395 328
32mm x 1"	1	75 395 308



COMPRESSION END CAP

Size (mm)	Pack quantity	Product Code
32mm	1	75 233 308



ENTRY BOOT

Size (mm)	Pack quantity	Product Code
32mm	1	75 270 308



COMPRESSION SPANNER

Size (mm)	Pack quantity	Product Code
32mm	1	75 SPA 431



PIPE CUTTER

Size (mm)	Pack quantity	Product Code
32mm	1	75 SPA 432



PLX EF COUPLER

Size (mm)	Pack quantity	Product Code
32mm	1	43 100 308



PLX EF 90° ELBOW

Size (mm)	Pack quantity	Product Code
32mm	1	43 104 308



PLX EF 45° ELBOW

Size (mm)	Pack quantity	Product Code
32mm	1	43 105 308



PLX EF SPIGOT END CAP

Size (mm)	Pack quantity	Product Code
32mm	1	43 233 308



PLX EF FEMALE BSP TRANSITION 39.5V

Size (mm)	Pack quantity	Product Code
32mm	1	43 741 308



PLX ELECTRICAL CONDUIT EF PREPARATION TOOL

Size (mm)	Pack quantity	Product Code
32mm	1	43 MZO 071

Air-Line Xtra

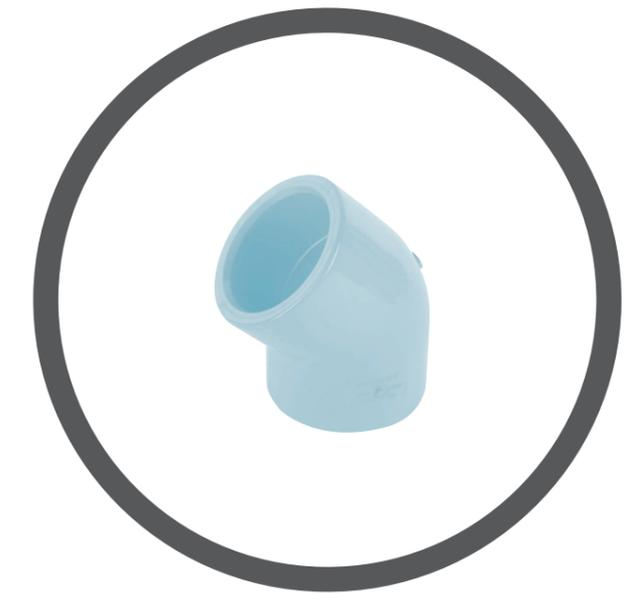
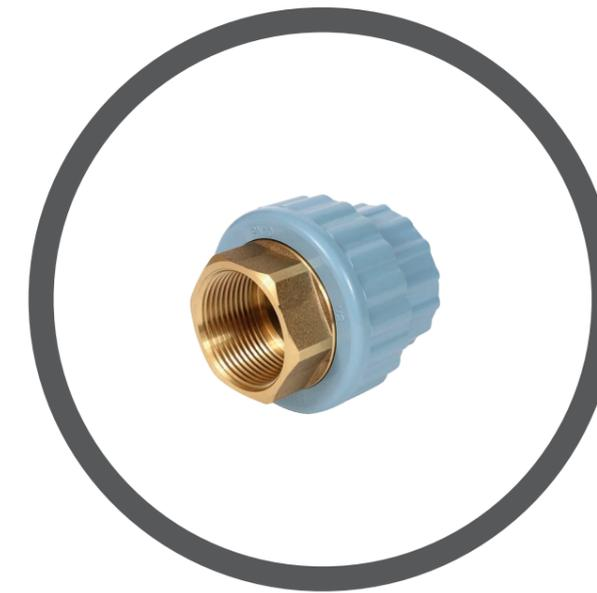
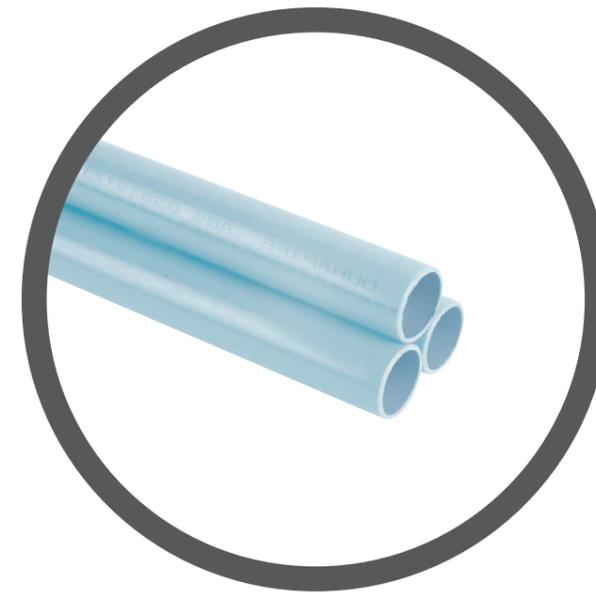

Air-Line Xtra

Pipe and fittings



PIPE - PN12.5 557

Pipe diameter (mm)	Standard length in metres	Standard pack qty in lengths	Product Code
16	5	50	31 557 305
20	5	50	31 557 306
25	5	50	31 557 307
32	5	50	31 557 308
40	5	25	31 557 309
50	5	15	31 557 310
63	5	10	31 557 311
75	5	5	31 557 312
90	5	5	31 557 313
110	5	5	31 557 314



SOCKETS - Plain 100

Size (mm)	Standard pack quantity	Product Code
16	10	31 100 305
20	10	31 100 306
25	10	31 100 307
32	10	31 100 308
40	10	31 100 309
50	10	31 100 310
63	5	31 100 311
75	1	31 100 312
90	1	31 100 313
110	1	31 100 314



REDUCING BUSHES - Plain 109

Size (mm)	Standard pack quantity	Product Code
20 x 16	10	31 109 412
25 x 20	10	31 109 415
32 x 16	10	31 109 417
32 x 25	10	31 109 419
40 x 32	10	31 109 423
50 x 20	10	31 109 424
50 x 25	10	31 109 425
50 x 32	10	31 109 426
50 x 40	10	31 109 427
63 x 25	10	31 109 429
63 x 32	10	31 109 430
63 x 50	10	31 109 432
75 x 63	5	31 109 438
90 x 50	5	31 109 442
90 x 63	5	31 109 443
90 x 75	5	31 109 444
110 x 63	1	31 109 449
110 x 90	1	31 109 451



REDUCERS - Plain/spigot x plain 114

Size (mm)	Standard pack quantity	Product Code
(25 or 20) x 16	10	31 114 412
(32 or 25) x 20	10	31 114 415
(40 or 32) x 25	10	31 114 419
(50 or 40) x 32	10	31 114 423
(63 or 50) x 40	5	31 114 427
(75 or 63) x 50	5	31 114 432
(90 or 75) x 63	1	31 114 438
(110 or 90) x 75	1	31 114 444



ELBOWS 45° - Plain 119

Size (mm)	Standard pack quantity	Product Code
16	10	31 119 305
20	10	31 119 306
25	10	31 119 307
32	10	31 119 308
40	10	31 119 309
50	10	31 119 310
63	5	31 119 311
75	5	31 119 312
90	5	31 119 313
110	1	31 119 314



ELBOWS 90° - Plain 115

Size (mm)	Standard pack quantity	Product Code
16	10	31 115 305
20	10	31 115 306
25	10	31 115 307
32	10	31 115 308
40	10	31 115 309
50	10	31 115 310
63	5	31 115 311
75	1	31 115 312
90	1	31 115 313
110	1	31 115 314



ELBOWS 90° - Plain 122

Size (mm)	Standard pack quantity	Product Code
16	10	31 122 305
20	10	31 122 306
25	10	31 122 307
32	10	31 122 308
40	10	31 122 309
50	5	31 122 310
63	5	31 122 311
75	1	31 122 312
90	1	31 122 313
110	1	31 122 314



TEES 90° - Reducing 124

Size (mm)	Standard pack quantity	Product Code
25 x 20	10	31 124 415
32 x 20	10	31 124 418
32 x 25	10	31 124 419
40 x 20	10	31 124 421
50 x 25	5	31 124 425
50 x 40	5	31 124 427
63 x 25	5	31 124 429
63 x 32	5	31 124 430
63 x 40	5	31 124 431

Air-Line Xtra

Pipe and fittings



BENDS 90° - Short radius 118

Size (mm)	Standard pack quantity	Product Code
16	10	31 118 305
20	10	31 118 306
25	10	31 118 307
32	10	31 118 308
40	5	31 118 309
50	5	31 118 310
63	1	31 118 311
75	1	31 118 312
90	1	31 118 313
110	1	31 118 314



DROPPER BENDS 180° - Plain 312

Size (mm)	Standard pack quantity	Product Code
16	10	31 312 305
20	10	31 312 306
25	10	31 312 307
32	10	31 312 308



SOCKETS - Plain/female BSP thread with metal reinforcing bond 101

Size (mm)	Standard pack quantity	Product Code
20 x 1/2	10	31 101 306
25 x 3/4	10	31 101 307
32 x 1	10	31 101 308



END CAPS - Plain 149

Size (mm)	Standard pack quantity	Product Code
16	10	31 149 305
20	10	31 149 306
25	10	31 149 307
32	10	31 149 308
40	10	31 149 309
50	10	31 149 310
63	5	31 149 311



END CAPS - Plain 149

Size (mm)	Standard pack quantity	Product Code
16	10	31 205 305
20	10	31 205 306
25	10	31 205 307
32	10	31 205 308
40	5	31 205 309
50	5	31 205 310
63	5	31 205 311

Standard seal EPDM. For unions with FKM seals please order 31 204 3**.



FEMALE THREADED ADAPTORS - Plain spigot/plain socket/female BSP thread with metal reinforcing band 153

Size (mm/inch)	Standard pack quantity	Product Code
16 x 12 x 3/8	10	31 153 331
20 x 16 x 1/2	10	31 153 333
25 x 20 x 3/4	10	31 153 335
32 x 25 x 1	10	31 153 337
40 x 32 x 1 1/4	5	31 153 339
50 x 40 x 1 1/2	5	31 153 341
63 x 50 x 2	5	31 153 343



COMPOSITE UNIONS - Plain/brass female BSP parallel thread 222

Size (mm/inch)	Standard pack quantity	Product Code
16 x 3/8	10	31 216 305
20 x 1/2	10	31 222 306
25 x 3/4	10	31 222 307
32 x 1	10	31 222 308
40 x 1 1/4	5	31 222 309
50 x 1 1/2	5	31 222 310
63 x 2	5	31 222 311



COMPOSITE UNIONS - Plain/brass male BSP taper thread 223

Size (mm/inch)	Standard pack quantity	Product Code
16 x 3/8	10	31 217 305
20 x 1/2	10	31 223 306
25 x 3/4	10	31 223 307
32 x 1	10	31 223 308
40 x 1 1/4	5	31 223 309
50 x 1 1/2	5	31 223 310
63 x 2	5	31 223 311



SS FEMALE COMPOSITE UNIONS - Air-line/Stainless Steel 316L, BSP parallel female 218

Size (mm/inch)	Standard pack quantity	Product Code
20 x 1/2	10	31 218 306
25 x 3/4	10	31 218 307
32 x 1	10	31 218 308
40 x 1 1/4	5	31 218 309
50 x 1 1/2	5	31 218 310
63 x 2	5	31 218 311

Air-Line Xtra

Pipe and fittings



SS MALE COMPOSITE UNIONS - Air-line/Stainless Steel 316L, BSP taper male 219

Size (mm/inch)	Standard pack quantity	Product Code
20 x 1/2	10	31 219 306
25 x 3/4	10	31 219 307
32 x 1	10	31 219 308
40 x 1 1/4	5	31 219 309
50 x 1 1/2	5	31 219 310
63 x 2	5	31 219 311



WALL BRACKETS - Multiport Female BSP Thread 430

Size (inch)	Standard pack quantity	Product Code
1/2 x 2 x 1/2 (Female inlet 1/2)	1	31 430 102
3/4 x 3 x 1/2 (Female inlet 3/4)	1	31 430 103



QUICK RELEASE ADAPTOR - Chrome / Stainless Steel / Male BSP Thread 431

Size (mm)	Standard pack quantity	Product Code
1/2	1	31 431 102



FLANGES STUB - Plain/serrated face 135

Size (mm)	Standard pack quantity	Product Code
32	10	31 135 308
40	10	31 135 309
50	5	31 135 310
63	5	31 135 311
75	5	31 135 312
90	1	31 135 313
110	1	31 135 314



GASKETS FLAT - Stub flange EPDM 411

Size (mm)	Standard pack quantity	Product Code
32	10	13 411 308
40	10	13 411 309
50	10	13 411 310
63	10	13 411 311
75	10	13 411 312
90	10	13 411 313
110	10	13 411 314



FLANGES BLANKING - Plain/drilled - Manufactured in grey ABS 323

Size (mm)	Standard pack quantity	Product Code
32	5	11 323 308
40	5	11 323 309
50	5	11 323 310
63	5	11 323 311
75	5	11 323 312
90	1	11 323 313
110	1	11 323 314

Blanking flanges are manufactured from grey ABS.



BACKING RINGS - Galvanised mild steel, drilled 421

Size (mm)	Standard pack quantity	Product Code
Drilled to BS EN1092-1, PN10/PN16 (Formerly BS 4504)		
32	1	13 421 308
40	1	13 421 309
50	1	13 421 310
63	1	13 421 311
75	1	13 421 312
90	1	13 421 313
110	1	13 421 314



VALVE SUPPORT PLATES - Galvanised mild steel, drilled 459

Size (mm)	Standard pack quantity	Product Code
Drilled to BS EN1092-1, PN10/PN16 (Formerly BS 4504)		
16	1	31 459 305
20	1	31 459 306
25	1	31 459 307
32	1	31 459 308
50	1	31 459 310
63	1	31 459 311
75	1	31 459 312
90	1	31 459 313
110	1	31 459 314



VKD DOUBLE UNION BALL VALVES - Manual - FKM seals

Size (mm)	Standard pack quantity	Product Code
16	1	HO DKB 305
20	1	HO DKB 306
25	1	HO DKB 307
32	1	HO DKB 308
40	1	HO DKB 309
50	1	HO DKB 310
63	1	HO DKB 311

Air-Line Xtra

Valves



LOCKABLE VKD DOUBLE UNION - ball valves Manual - FKM seals

Size (mm)	Standard pack quantity	Product Code
16	1	HO DLB 305
20	1	HO DLB 306
25	1	HO DLB 307
32	1	HO DLB 308
40	1	HO DLB 309
50	1	HO DLB 310
63	1	HO DLB 311



FK BUTTERFLY VALVES - Manufactured from glass reinforced PP with PP disc

Size (mm)	Standard pack quantity	Product Code
75	1	HO FKP 108
90	1	HO FKP 109
110	1	HO FKP 110



AIR-LINE XTRA SOLVENT CEMENT

Contents	Standard pack quantity	Product Code
1/2 litre	12	31 464 395



ECO CLEANER

Contents	Standard pack quantity	Product Code
1/2 litre	12	03 457 395

Durapipe Corzan CPVC

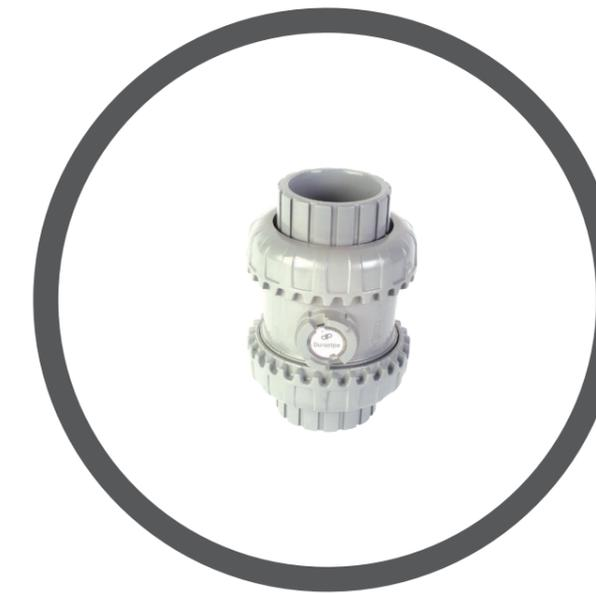

Durapipe Corzan CPVC

Pipe and fittings



PIPE - PN16 Plain ended 560

Pipe diameter (mm)	Standard length in metres	Product Code
16	5	38 560 305
20	5	38 560 306
25	5	38 560 307
32	5	38 560 308
40	5	38 560 309
50	5	38 560 310
63	5	38 560 311
75	5	38 560 312
90	5	38 560 313
110	5	38 560 314
160	5	38 560 317



PIPE - PN10 Plain ended 555

Pipe diameter (mm)	Standard length in metres	Product Code
160	5	38 555 317



REDUCING BUSHES - Plain 109

Size (mm)	Standard pack quantity	Product Code
20 x 16	10	38 109 412
25 x 20	10	38 109 415
32 x 20	10	38 109 418
32 x 25	10	38 109 419
40 x 20	10	38 109 421
40 x 25	10	38 109 422
40 x 32	10	38 109 423
50 x 32	10	38 109 426
50 x 40	10	38 109 427
63 x 32	5	38 109 430
63 x 40	5	38 109 431
63 x 50	5	38 109 432
75 x 50	2	38 109 437
75 x 63	2	38 109 438
90 x 50	2	38 109 442
90 x 63	2	38 109 443
90 x 75	2	38 109 444
110 x 63	2	38 109 449
110 x 75	2	38 109 450
110 x 90	2	38 109 451
160 x 110	2	38 109 474



SOCKETS - Plain 100

Size (mm)	Standard pack quantity	Product Code
16	10	38 100 305
20	10	38 100 306
25	10	38 100 307
32	10	38 100 308
40	10	38 100 309
50	10	38 100 310
63	5	38 100 311
75	2	38 100 312
90	2	38 100 313
110	2	38 100 314
160	1	38 100 317



ELBOWS 45° - Plain 119

Size (mm)	Standard pack quantity	Product Code
20	10	38 119 306
25	10	38 119 307
32	10	38 119 308
40	5	38 119 309
50	5	38 119 310
63	5	38 119 311
75	2	38 119 312
90	2	38 119 313
110	2	38 119 314
160	1	38 119 317



ELBOWS 90° - Plain 115

Size (mm)	Standard pack quantity	Product Code
16	10	38 115 305
20	10	38 115 306
25	10	38 115 307
32	10	38 115 308
40	10	38 115 309
50	10	38 115 310
63	5	38 115 311
75	2	38 115 312
90	2	38 115 313
110	2	38 115 314
160	1	38 115 317



TEES 90° EQUAL - Plain 122

Size (mm)	Standard pack quantity	Product Code
16	10	38 122 305
20	10	38 122 306
25	10	38 122 307
32	10	38 122 308
40	10	38 122 309
50	10	38 122 310
63	5	38 122 311
75	2	38 122 312
90	2	38 122 313
110	2	38 122 314
160	1	38 122 317



TEES 90° - Reducing 124

Size (mm)	Standard pack quantity	Product Code
25 x 20	10	38 124 415
32 x 20	10	38 124 418
32 x 25	10	38 124 419
40 x 20	10	38 124 421
40 x 25	10	38 124 422
50 x 25	10	38 124 425
50 x 32	10	38 124 426
63 x 25	10	38 124 429
63 x 32	10	38 124 430
75 x 25	5	38 124 434
90 x 25	5	38 124 439
110 x 25	5	38 124 445



END CAPS - Plain 140

Size (mm)	Standard pack quantity	Product Code
20	10	38 140 306
25	10	38 140 307
32	10	38 140 308
40	10	38 140 309
50	10	38 140 310
63	5	38 140 311
75	2	38 140 312
90	2	38 140 313
110	2	38 140 314



SOCKET UNIONS - Plain - EPDM 205

Size (mm)	Standard pack quantity	Product Code
16	10	38 205 305
20	10	38 205 306
25	10	38 205 307
32	10	38 205 308
40	10	38 205 309
50	10	38 205 310
63	5	38 205 311

FKM available to order type 204.



ADAPTOR NIPPLES - Plain female/ threaded male 171

Size (mm/inch)	Standard pack quantity	Product Code
16 x 20 x 3/8	10	38 171 332
20 x 25 x 1/2	10	38 171 334
25 x 32 x 3/4	10	38 171 336
32 x 40 x 1	10	38 171 338
40 x 50 x 1 1/4	10	38 171 340
50 x 63 x 1 1/2	5	38 171 342
63 x 75 x 2	5	38 171 345



COMPOSITE UNIONS - Plain/brass male BSP taper thread 223

Size (mm/inch)	Standard pack quantity	Product Code
16 x 3/8	5	38 217 305
20 x 1/2	5	38 223 306
25 x 3/4	5	38 223 307
32 x 1	2	38 223 308
40 x 1 1/4	2	38 223 309
50 x 1 1/2	2	38 223 310
63 x 2	2	38 223 311



COMPOSITE UNIONS - Plain/brass female BSP parallel thread 222

Size (mm/inch)	Standard pack quantity	Product Code
16 x 3/8	5	38 216 305
20 x 1/2	5	38 216 306
25 x 3/4	5	38 216 307
32 x 1	2	38 216 308
40 x 1 1/4	2	38 216 309
50 x 1 1/2	2	38 216 310
63 x 2	2	38 216 311



TEES 90° - Threaded branch with reinforcing ring 121

Size (mm/inch)	Standard pack quantity	Product Code
16 x 3/8	10	38 121 305
20 x 1/2	10	38 121 306
25 x 3/4	10	38 121 307
32 x 1	10	38 121 308
40 x 1 1/4	10	38 121 309
50 x 1 1/2	10	38 121 310
63 x 2	10	38 121 311



ELBOWS 90° - Plain/BSP female thread with reinforcing ring 178

Size (mm/inch)	Standard pack quantity	Product Code
16 x 3/8	10	38 178 305
20 x 1/2	10	38 178 306
25 x 3/4	10	38 178 307
32 x 1	10	38 178 308
40 x 1 1/4	10	38 178 309
50 x 1 1/2	10	38 178 310
63 x 2	10	38 178 311

Durapipe Corzan CPVC

Pipe and fittings



ADAPTOR SOCKETS - Plain/BSP female thread with reinforcing ring

103

Size (mm/inch)	Standard pack quantity	Product Code
16 x 3/8	10	38 103 602
20 x 1/2	10	38 103 306
25 x 3/4	10	38 103 307
32 x 1	10	38 103 308
40 x 1 1/4	10	38 103 309
50 x 1 1/2	10	38 103 310
63 x 2	5	38 103 311



SOCKET UNIONS - Plain/threaded - EPDM 202

Size (mm/inch)	Standard pack quantity	Product Code
16 x 3/8	10	38 202 305
20 x 1/2	10	38 202 306
25 x 3/4	10	38 202 307
32 x 1	10	38 202 308
40 x 1 1/4	10	38 202 309
50 x 1 1/2	10	38 202 310
63 x 2	10	38 202 311

FKM seals available.



FLANGES STUB - Plain/serrated face 135

Size (mm)	Standard pack quantity	Product Code
20	10	38 135 306
25	10	38 135 307
32	10	38 135 308
40	10	38 135 309
50	10	38 135 310
63	2	38 135 311
75	2	38 135 312
90	2	38 135 313
110	2	38 135 314
160	1	38 135 317



GASKETS FLAT - Stub flange - FKM 411/432

Size (mm)	Standard pack quantity	Product Code
FKM		
20	1	23 432 306
25	1	23 432 307
32	1	23 432 308
40	1	23 432 309
50	1	23 432 310
63	1	23 432 311
75	1	23 432 312
90	1	23 432 313
110	1	23 432 314
160	1	23 432 317

Note: For EPDM Gaskets, order via Code 13 411 ***



PP/FRP STEEL CORE BACKING RINGS - DIN2501 drilled to PN10/PN16 (compatible with BS EN 1092-1) 421

Size (mm)	Standard pack quantity	Product Code
20*	1	18 421 306
25*	1	18 421 307
32*	1	18 421 308
40*	1	18 421 309
50*	1	18 421 310
63*	1	18 421 311
75*	1	18 421 312
90*	1	18 421 313
110*	1	18 421 314
160*	1	18 421 317

* Made to Order (Please refer to our Terms & Conditions).



BACKING RINGS - Galvanised mild steel, drilled 448/421

Size (mm)	Standard pack quantity	Product Code
Drilled to ANSI 150		
20	1	13 448 306
25	1	13 448 307
32	1	13 448 308
40	1	13 448 309
50	1	13 448 310
63	1	13 448 311
75	1	13 448 312
90	1	13 448 313
110	1	13 448 314
160	1	13 448 317

Drilled to BS EN1029-1, PN10/PN16 (Formerly BS 4504)

25	1	13 421 307
32	1	13 421 308
40	1	13 421 309
50	1	13 421 310
63	1	13 421 311
75	1	13 421 312
90	1	13 421 313
110	1	13 421 314
160	1	13 421 317

Durapipe Corzan CPVC

Valves and accessories



PP/FRP STEEL CORE BACKING RING - ANSI drilled 448

Size (mm)	Standard pack quantity	Product Code
20*	1	18 448 306
25*	1	18 448 307
32*	1	18 448 308
40*	1	18 448 309
50*	1	18 448 310
63*	1	18 448 311
75*	1	18 448 312
90*	1	18 448 313

* Made to Order (Please refer to our Terms & Conditions).



VKD DOUBLE UNION BALL VALVES - Manual - FKM seals

Size (mm)	Standard pack quantity	Product Code
16	1	HO DKK 305
20	1	HO DKK 306
25	1	HO DKK 307
32	1	HO DKK 308
40	1	HO DKK 309
50	1	HO DKK 310
63	1	HO DKK 311



LOCKABLE VKD DOUBLE UNION BALL VALVES - Manual - FKM seals

Size (mm)	Standard pack quantity	Product Code
16	1	HO DLK 305
20	1	HO DLK 306
25	1	HO DLK 307
32	1	HO DLK 308
40	1	HO DLK 309
50	1	HO DLK 310
63	1	HO DLK 311



VKD DOUBLE UNION BALL VALVES - Manual - FKM seals

Size (mm)	Standard pack quantity	Product Code
75	1	HO DKK 312
90	1	HO DKK 313
110	1	HO DKK 314

Lockable handle as standard.



VXE EASYFIT DOUBLE UNION BALL VALVES - Manual - EPDM seals

Size (mm)	Standard pack quantity	Product Code
16	1	HO XEJ 305
20	1	HO XEJ 306
25	1	HO XEJ 307
32	1	HO XEJ 308
40	1	HO XEJ 309
50	1	HO XEJ 310
63	1	HO XEJ 311
75*	1	HO XEJ 312
90*	1	HO XEJ 313
110*	1	HO XEJ 314

* FIG B.



VXE EASYFIT DOUBLE UNION BALL VALVES - Manual - FKM seal

Size (mm)	Standard pack quantity	Product Code
16	1	HO XEK 305
20	1	HO XEK 306
25	1	HO XEK 307
32	1	HO XEK 308
40	1	HO XEK 309
50	1	HO XEK 310
63	1	HO XEK 311
75*	1	HO XEK 312
90*	1	HO XEK 313
110*	1	HO XEK 314

* FIG B.

Durapipe Corzan CPVC

Valves and accessories



SET OF TRANSPARENT SERVICE PLUGS AND WHITE PVC TAG HOLDERS - For insertion in handle for VXE Easyfit valve customisation

Size (mm/inch)	Standard pack quantity	Product Code
16-20 x 1/2	20	LCE020
25 x 3/4	20	LCE025
32 x 1	20	LCE032
40 x 1 1/4	20	LCE040
50 x 1 1/2	20	LCE050
63 x 2	20	LCE063



SET OF TRANSPARENT SERVICE PLUGS AND WHITE PVC TAG HOLDERS - For insertion in handle for VXE Easyfit valve customisation

Size (mm/inch)	Total labels	Total labels	Product Code
16-20 x 1/2	10	500	LSE020
25 x 3/4	10	500	LSE025
32 x 1	10	500	LSE032
40 x 1 1/4	10	500	LSE040
50 x 1 1/2	10	400	LSE050
63 x 2	10	400	LSE063



TKD 3-WAY BALL VALVES T-PORT - Plain female ends - FKM seals

Size (inch)	Standard pack quantity	Product Code
20	1	HO TTK 306
25	1	HO TTK 307
32	1	HO TTK 308
40	1	HO TTK 309
50	1	HO TTK 310
63	1	HO TTK 311

*Locking handle options are available upon request, please order shape Code "TLK".



TKD 3-WAY BALL VALVES L-PORT - Plain female ends - FKM seals

Size (inch)	Standard pack quantity	Product Code
20	1	HO LTK 306
25	1	HO LTK 307
32	1	HO LTK 308
40	1	HO LTK 309
50	1	HO LTK 310
63	1	HO LTK 311

*Locking handle options are available upon request, please order shape Code "LLK".



DIALOCK® DIAPHRAGM VALVES MANUAL - Plain union ends - FKM seals

Size (mm)	Standard pack quantity	Product Code
20	1	HO DVK 306
25	1	HO DVK 307
32	1	HO DVK 308
40	1	HO DVK 309
50	1	HO DVK 310
63	1	HO DVK 311
75*	1	HO DVK 312

*75mm product is supplied with plain spigot ends.

EPDM (code DKJ) ptfе (code DKL) seal options available.



VM DIAPHRAGM VALVES - Manual - plain spigot ends - FKM seals

Size (mm)	Standard pack quantity	Product Code
90	1	HO VMK 413
110	1	HO VMK 414

EPDM (code DKJ) ptfе (code DKL) seal options available.



FK BUTTERFLY VALVES - Glass reinforced Polypropylene with CPVC disc, FKM liner Lever operated

Size (mm)	Standard pack quantity	Product Code
50	1	HO FKK 106
63	1	HO FKK 107
75	1	HO FKK 108
90	1	HO FKK 109
110	1	HO FKK 110
160	1	HO FKK 112



RV Y-TYPE STRAINERS - Plain ends - FKM seals

Size (mm)	Standard pack quantity	Product Code
20	1	HO UVK 306
25	1	HO UVK 307
32	1	HO UVK 308
40	1	HO UVK 309
50	1	HO UVK 310
63	1	HO UVK 311



SS EASYFIT BALL CHECK VALVES - Plain female ends - FKM seals

Size (mm)	Standard pack quantity	Product Code
20	1	HO SSK 306
25	1	HO SSK 307
32	1	HO SSK 308
40	1	HO SSK 309
50	1	HO SSK 310
63	1	HO SSK 311



SS EASYFIT BALL CHECK VALVES - Plain female ends - FKM seals

Size (mm)	Standard pack quantity	Product Code
75	1	HO SSK 312
90	1	HO SSK 313
110	1	HO SSK 314



COBRA PIPE CLIPS 434

Size (mm)	Standard pack quantity	Product Code
16	10	13 434 305
20	10	13 434 306
25	10	13 434 307
32	10	13 434 308
40	10	13 434 309
50	10	13 434 310
63	10	13 434 311
75	10	13 434 312
90	10	13 434 313
110	10	13 434 314
160	10	13 434 317

Note: 16 to 25mm not supplied with retaining straps.



CORZAN SOLVENT CEMENT 462

Contents	Standard pack quantity	Product Code
1/2 litre	12	38 462 395



ECO CLEANER 457

Contents	Standard pack quantity	Product Code
1/2 litre	12	03 457 395

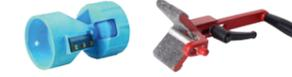

CHAMFERING AND DE-BURRING TOOLS

Description	Product Code
16-63mm pipe inner and outer milling cutter tool	FT 55 65 12
32-160mm chamfering tool	FT 55 05 10



PIPE CUTTERS

Description	Product Code
16-63mm pipe cutter	FT 80 00 01
50-125mm pipe cutter	FT 80 00 03
16-63mm spare cutter wheel	FT 80 00 02
50-125mm spare cutter wheel	FT 80 00 04

Durapipe Guardian

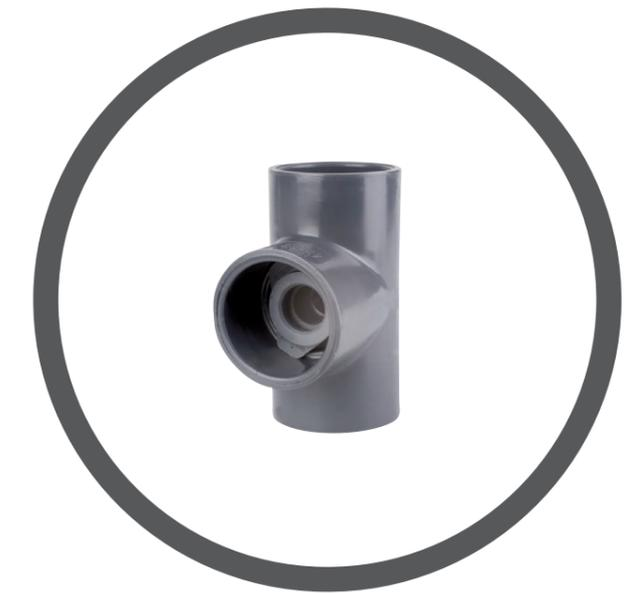

Durapipe Guardian

PVC-U Dual Contained System



PIPE - PVC-U 513

Pipe diameter (inch)	Standard length in metres	Product Code
1/2#2	6	08 513 102
3/4 #3	6	08 513 103
1#3	6	08 513 104
1 1/2 #4	6	08 513 106
2#4	6	08 513 107
3#6	6	08 513 109
4#8	6	08 513 110
6#10	6	08 513 112
8#12	6	08 512 113

All pipe sizes are Class E inside of Class C, except for the 8"-12" which is Class C inside Class D.



PIPE - PVC-U clear outer 514

Pipe diameter (inch)	Standard length in metres	Product Code
1/2#2	6	08 514 102
3/4 #3	6	08 514 103
1#3	6	08 514 104
1 1/2 #4	6	08 514 106
2#4	6	08 514 107
3#6	6	08 514 109
4#8	6	08 514 110

This product is supplied as:
 1x 6m length PVC-U Grey Inner Pipe
 2x 3m length PVC-U Clear Outer Pipe
 1x PVC-U Socket
 6x Centra-Guide Guardian Pipe Spacers.



SOCKETS (MLV) - Plain 100

Size (inch)	Standard pack quantity	Product Code
1/2	10	02 100 102
3/4	10	02 100 103
1	10	02 100 104
1 1/4	10	02 100 105
1 1/2	10	02 100 106
2	10	02 100 107
2 1/2	5	33 100 312
3	1	02 100 109
4	1	02 100 110
5	1	33 100 316
6	1	02 100 112
8	1	02 100 113
10*	1	02 100 114
12*	1	02 100 115

* Made to Order (Please refer to our Terms & Conditions).

Single wall PVC-U sockets are to be utilised to join primary and secondary pipe lengths together,



ZONE FITTINGS - Plain 496

Pipe diameter (inch)	Standard pack quantity	Product Code
1/2#2	1	08 496 102
3/4 #3	1	08 496 103
1#3	1	08 496 104
1 1/2 #4	1	08 496 106
2#4	1	08 496 107
3#6	1	08 496 109
4#8	1	08 496 110



ELBOWS 45° - Plain 119

Pipe diameter (inch)	Standard pack quantity	Product Code
1/2#2	10	08 119 102
3/4 #3	5	08 119 103
1#3	5	08 119 104
1 1/2 #4	5	08 119 106
2#4	5	08 119 107
3#6	5	08 119 109
4#8	2	08 119 110
6#10*	1	08 119 112
8#12*	1	08 119 113

* Made to Order (Please refer to our Terms & Conditions).



TEES 90° EQUAL - Plain 122

Pipe diameter (inch)	Standard pack quantity	Product Code
1/2#2	10	08 122 102
3/4 #3	5	08 122 103
1#3	5	08 122 104
1 1/2 #4	5	08 122 106
2#4	5	08 122 107
3#6	5	08 122 109
4#8	2	08 122 110
6#10*	1	08 122 112
8#12*	1	08 122 113

* Made to Order (Please refer to our Terms & Conditions).



ELBOWS 90° - Plain 122

Pipe diameter (inch)	Standard pack quantity	Product Code
1/2#2	10	08 115 102
3/4 #3	5	08 115 103
1#3	5	08 115 104
1 1/2 #4	5	08 115 106
2#4	5	08 115 107
3#6	5	08 115 109
4#8	2	08 115 110
6#10*	1	08 115 112
8#12*	1	08 115 113

* Made to Order (Please refer to our Terms & Conditions).



VKD DOUBLE UNION BALL VALVES - Manual - EPDM seals

Pipe diameter (inch)	Standard pack quantity	Product Code
1/2#2	1	08 DKE 102
3/4 #3	1	08 DKE 103
1#3	1	08 DKE 104
1 1/2 #4	1	08 DKE 106
2#4	1	08 DKE 107
3#6	1	08 DKE 109
4#8	1	08 DKE 110

FKM seal options are also available, order by using Code 08 DKF 1**.



TERMINATION FITTINGS with tap 143

Pipe diameter (inch)	Standard pack quantity	Product Code
1/2#2	1	08 143 102
3/4 #3	1	08 143 103
1#3	1	08 143 104
1 1/2 #4	1	08 143 106
2#4	1	08 143 107
3#6	1	08 143 109
4#8	1	08 143 110
6#10	1	08 143 112
8#10	1	08 143 113

FKM seal options are also available, please enquire for details.



STANDARD LEAK DETECTION KIT - Consisting of equal tee, bush, 1m clear PVC pipe and VXE Easyfit PVC ball valve 191

Pipe diameter (inch)	Product Code
2	08 191 107
3	08 191 109
4	08 191 110
6	08 191 112
8	08 191 113
10*	08 191 114
12*	08 191 115

* Made to Order (Please refer to our Terms & Conditions).

RETROFIT LEAK DETECTION KIT - Consisting of clamp saddle, threaded socket, threaded adaptor, 1m clear PVC pipe and VXE Easyfit PVC ball valve 192

Pipe diameter (inch)	Product Code
2	08 192 107
3	08 192 109
4	08 192 110
6	08 192 112
8	08 192 113

For managed leak detection systems please contact our approved leak detection specialist below:

Afriso Eurogauge

Please contact our technical team for further information:

Tel: +44 (0) 1293 658365

www.eurogauge.co.uk

GPS PE Black

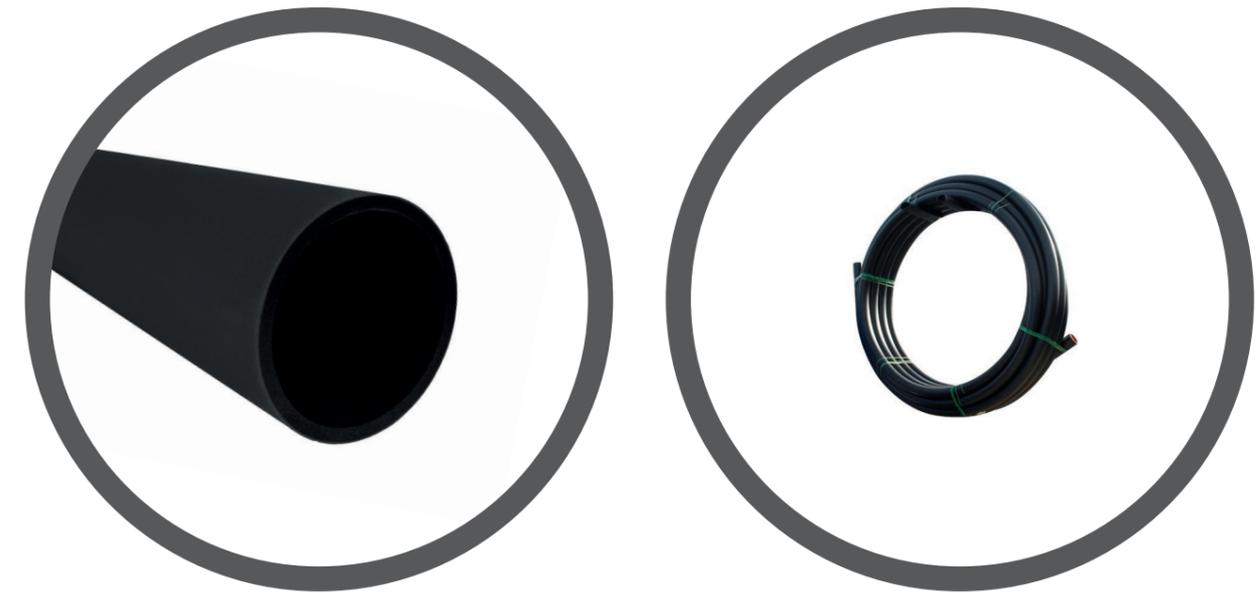

GPS PE Black

Pipe and coils



STICKS SDR 11

Size (mm)	Length (m)	Product Code
50	6	50 512 310
63	6	50 513 311
75	6	40 512 313
	12	40 527 313
90	6	40 512 314
	12	40 527 314
110	6	40 512 315
	12	40 527 315
125	6	40 512 317
	12	40 527 317
160	6	40 512 318
	12	40 527 318
180	6	40 512 319
	12	40 527 319
200	6	40 512 320
	12	40 527 320
225	6	40 512 321
	12	40 527 321
250	6	40 512 322
	12	40 527 322
280	6	40 512 323
	12	40 527 323
315	6	40 512 324
	12	40 527 324
355	6	40 512 325
	12	40 527 325
400	6	40 512 326
	12	40 527 326
450	6	40 512 327
	12	40 527 327
500	6	40 512 328
	12	40 527 328
560	6	40 512 329
	12	40 527 329
630	6	40 512 330
	12	40 527 330
710	6	40 512 330
	12	40 527 330

COILS SDR 11

Size (mm)	Length (m)	Product Code
20*	25	50 558 306
	50	50 559 306
	100	50 560 306
25	150	50 561 306
	25	50 558 307
	50	50 559 307
32	100	50 560 307
	150	50 561 307
	25	50 558 308
50	50	50 559 308
	100	50 560 308
	150	50 561 308
63	25	50 558 310
	50	50 559 310
	100	50 560 310
90	150	50 561 310
	25	50 558 311
	50	50 559 311
110	100	50 560 311
	150	50 561 311
	50	40 559 312
125	100	40 560 312
	50	40 559 313
140	100	40 560 313
	50	40 559 314
160	100	40 560 314
	50	40 559 315
180	100	40 560 315
	50	40 559 317
200	100	40 560 317
	50	40 559 318
225	100	40 560 318
	50	40 560 318

*SDR 9

STICKS SDR 17

Size (mm)	Length (m)	Product Code
90	6	40 506 313
	12	40 507 313
110	6	40 506 314
	12	40 507 314
125	6	40 506 315
	12	40 507 315
160	6	40 506 317
	12	40 507 317
180	6	40 506 318
	12	40 507 318
200	6	40 506 319
	12	40 507 319
225	6	40 506 320
	12	40 507 320
250	6	40 506 321
	12	40 507 321
280	6	40 506 322
	12	40 507 322
315	6	40 506 323
	12	40 507 323
355	6	40 506 324
	12	40 507 324
400	6	40 506 325
	12	40 507 325
450	6	40 506 326
	12	40 507 326
500	6	40 506 327
	12	40 507 327
560	6	40 506 328
	12	40 507 328
630	6	40 506 329
	12	40 507 329
710	6	40 506 330
	12	40 507 330
800	6	40 506 332
	12	40 507 332
900	6	40 506 333
	12	40 507 333

STICKS SDR 17

Size (mm)	Length (m)	Product Code
1000	6	40 506 334
	12	40 507 334
1200	6	40 506 335
	12	40 507 335



COILS SDR 17

Size (mm)	Length (m)	Product Code
75	50	40 548 312
	100	40 549 312
90	50	40 548 313
	100	40 549 313
110	50	40 548 314
	100	40 549 314
125	50	40 548 315
	100	40 549 315
160	50	40 548 317
	100	40 549 317
180	50	40 548 318
	100	40 549 318

GPS PE Black

Pipe and coils



STICKS SDR 21

Size (mm)	Length (m)	Product Code
160	6	40 519 317
	12	40 539 317
180	6	40 519 318
	12	40 539 318
200	6	40 519 319
	12	40 539 319
225	6	40 519 320
	12	40 539 320
250	6	40 519 321
	12	40 539 321
280	6	40 519 322
	12	40 539 322
315	6	40 519 323
	12	40 539 323
355	6	40 519 324
	12	40 539 324
400	6	40 519 325
	12	40 539 325
450	6	40 519 326
	12	40 539 326
500	6	40 519 327
	12	40 539 327
560	6	40 519 328
	12	40 539 328
630	6	40 519 329
	12	40 539 329
710	6	40 519 330
	12	40 539 330
800	6	40 519 332
	12	40 539 332
900	6	40 519 333
	12	40 539 333
1000	6	40 519 334
	12	40 539 334
1200	6	40 519 335
	12	40 539 335

STICKS SDR 26

Size (mm)	Length (m)	Product Code
160	6	40 518 317
	12	40 528 317
180	6	40 518 318
	12	40 528 318
200	6	40 518 319
	12	40 528 319
225	6	40 518 320
	12	40 528 320
250	6	40 518 321
	12	40 528 321
280	6	40 518 322
	12	40 528 322
315	6	40 518 323
	12	40 528 323
355	6	40 518 324
	12	40 528 324
400	6	40 518 325
	12	40 528 325
450	6	40 518 326
	12	40 528 326
500	6	40 518 327
	12	40 528 327
560	6	40 518 328
	12	40 528 328
630	6	40 518 329
	12	40 528 329
710	6	40 518 330
	12	40 528 330
800	6	40 518 332
	12	40 528 332
900	6	40 518 333
	12	40 528 333
1000	6	40 518 334
	12	40 528 334
1200	6	40 518 335
	12	40 528 335

Frialen electrofusion fittings



Frialen electrofusion fittings

For all applications



COUPLERS – Removable Centre Stop SDR11

Size (mm)	SDR	Product Code
20	11	FL 612 680
25	11	FL 612 681
32	11	FL 612 682
40	11	FL 612 683
50	11	FL 612 684
63	11	FL 612 685
75	11	FL 612 686
90	11	FL 612 687
110	11	FL 612 688
125	11	FL 612 689
140	11	FL 612 690
160	11	FL 612 691



FRIAFIT COUPLERS – Slideover

Size (mm)	SDR	Product Code
110	17	FF 680 001
125	17	FF 680 013
160	17	FF 680 002
180	17	FF 680 003
200	17	FF 680 004
225	17	FF 680 005
250	17	FF 680 006
280	17	FF 680 007



COUPLERS – Slideover SDR 11 & 17

Size (mm)	SDR	Product Code
180	11	FL 612 672
200	11	FL 612 673
225	11	FL 612 674
250	11	FL 612 675
280	11	FL 615 073
315	11	FL 612 670
355	11	FL 615 074
400	11	FL 615 075
450	11	FL 615 076
500	11	FL 615 124
560	11	FL 613 312
	17	FL 615 706
630	11	FL 616 269
	17	FL 615 726
710	11	FL 616 313
	17	FL 615 994
800	11	FL 616 314
	17	FL 616 290
900	17	FL 616 345
1000	17	FL 616 403
1200	17	FL 616 416



COUPLERS – Slideover SDR 7.4

Size (mm)	SDR	Product Code
90	7.4	FL 616 270
110	7.4	FL 616 271
125	7.4	FL 616 272
140	7.4	FL 616 273
160	7.4	FL 616 274
180	7.4	FL 616 282
200	7.4	FL 616 283
225	7.4	FL 616 284
250	7.4	FL 616 285
315	7.4	FL 616 287
355	7.4	FL 616 288



COUPLERS – Slideover SDR 9

Size (mm)	SDR	Product Code
400	9	FL 616 441
450	9	FL 616 447
500	9	FL 616 445
560	9	FL 616 446
630	9	FL 616 439



LONG COUPLERS – Removable Centre Stop

Size (mm)	SDR	Product Code
32	11	FL 615 736
40	11	FL 615 737
50	11	FL 615 608
63	11	FL 615 738



CONICAL RING COUPLERS

Size (mm)	SDR	Product Code
1000	17	FL 616 434
1200	17	FL 616 435

Frialen electrofusion fittings

For all applications



REDUCERS

Size (mm)	SDR	Product Code
32 x 20	11	FL 615 386
32 x 25	11	FL 615 502
40 x 20	11	FL 615 387
40 x 32	11	FL 615 388
50 x 20	11	FL 612 069
50 x 32	11	FL 612 070
50 x 40	11	FL 612 071
63 x 32	11	FL 615 389
63 x 40	11	FL 615 390
63 x 50	11	FL 612 072
90 x 50	11	FL 615 391
90 x 63	11	FL 615 392
110 x 63	11	FL 615 393
110 x 90	11	FL 615 693
125 x 90	11	FL 615 694
125 x 110	11	FL 616 510
160 x 110	11	FL 615 695
160 x 125	11	FL 616 511
225 x 160	11	FL 616 356



REDUCERS

Size (mm)	SDR	Product Code
250 x 180	11	FL 402 529
315 x 250	11	FL 402 543



UNDER CLAMP SPIGOT SADDLES

Size (mm)	SDR	Product Code
63 x 32	11	FL 612 757
63 x 50	11	FL 612 759
75 x 50	11	FL 615 020
90 x 32	11	FL 615 285
90 x 63	11	FL 612 819
110 x 32	11	FL 615 334
110 x 50	11	FL 615 031
110 x 63	11	FL 612 760
110 x 90	11	FL 615 411
125 x 32	11	FL 615 087
125 x 63	11	FL 612 761
125 x 90	11	FL 615 412
125 x 110	11	FL 615 584
160 x 32	11	FL 612 886
160 x 63	11	FL 612 762
160 x 90	11	FL 615 413
160 x 110	11	FL 615 739
160 x 125	11	FL 615 585
180 x 63	11	FL 612 763
180 x 90	11	FL 615 414
180 x 110	11	FL 615 948
180 x 125	11	FL 615 740
200 x 63	11	FL 612 764
225 x 63	11	FL 612 765
225 x 90	11	FL 615 415
225 x 110	11	FL 616 044
225 x 125	11	FL 616 045
225 x 160	11	FL 616 046



TOP LOADING SPIGOT SADDLES

Size (mm)	SDR	Product Code
250-560(630) x 32	11	FL 615 465
250-560(630) x 63	11	FL 615 466



EQUAL TEES

Size (mm)	SDR	Product Code
25	11	FL 616 338
32	11	FL 615 719
40	11	FL 615 720
50	11	FL 615 721
63	11	FL 615 722



EQUAL TEES

Size (mm)	SDR	Product Code
75	11	FL 612 165
90	11	FL 612 166
110	11	FL 612 167
125	11	FL 612 168
160	11	FL 615 277
180	11	FL 615 691
200	11	FL 616 266
225	11	FL 615 692



LARGE DIAMETER EQUAL TEES

Size (mm)	SDR	Product Code
250	11	FL 616 412
280	11	FL 616 413
315	11	FL 616 414



REDUCED BRANCH TEES

Size (mm)	SDR	Product Code
32 x 20	11	FL 616 417
40 x 32	11	FL 616 418
50 x 32	11	FL 616 419
50 x 40	11	FL 616 420
63 x 32	11	FL 616 421
63 x 40	11	FL 616 422
63 x 50	11	FL 616 423

Frialen electrofusion fittings

For all applications



90° ELBOWS

Size (mm)	SDR	Product Code
25	11	FL 612 091
32	11	FL 612 093
40	11	FL 612 095
50	11	FL 612 097
63	11	FL 612 099
75	11	FL 612 101
90	11	FL 612 103
110	11	FL 612 105
125	11	FL 612 107
160	11	FL 615 276
180	11	FL 615 689
200	11	FL 616 265
225	11	FL 615 690



LARGE DIAMETER 90° ELBOWS

Size (mm)	SDR	Product Code
250	11	FL 616 408
280	11	FL 616 409
315	11	FL 616 410



45° ELBOWS

Size (mm)	SDR	Product Code
32	11	FL 612 092
40	11	FL 612 094
50	11	FL 612 096
63	11	FL 612 098
75	11	FL 612 100
90	11	FL 612 102
110	11	FL 612 104
125	11	FL 612 106
160	11	FL 615 275
180	11	FL 615 687
200	11	FL 616 264
225	11	FL 615 688



LARGE DIAMETER 45° ELBOWS

Size (mm)	SDR	Product Code
250	11	FL 616 404
280	11	FL 616 405
315	11	FL 616 406



30° ELBOWS

Size (mm)	SDR	Product Code
90	11	FL 615 272
110	11	FL 615 273
125	11	FL 615 274
160	11	FL 615 340
180	11	FL 616 261
200	11	FL 616 262
225	11	FL 616 263



END CAPS

Size (mm)	SDR	Product Code
20	11	FL 612 025
25	11	FL 612 026
32	11	FL 612 027
40	11	FL 612 028
50	11	FL 612 029
63	11	FL 612 030
75	11	FL 612 031
90	11	FL 612 032
110	11	FL 612 033
125	11	FL 612 034
160	11	FL 612 035
180	11	FL 616 183
200	11	FL 616 184
225	11	FL 616 185



REINFORCING SADDLES

Size (mm)	SDR	Product Code
63	11	FL 612 519



FULL FACED FLANGED BRANCH SADDLES

Size (mm)	SDR	Product Code
110 x 80 PN16	11	FL 616 016
125 x 80 PN16	11	FL 616 017
160 x 80 PN16	11	FL 616 018
180 x 80 PN16	11	FL 616 019
225 x 80 PN16	11	FL 616 020
160 x 100 PN16	11	FL 616 022
225 x 100 PN16	11	FL 616 024

Frialen electrofusion fittings

For all applications



REPAIR & REINFORCING SADDLES

Size (mm)	SDR	Product Code
90	11	FL 615 164
110	11	FL 615 165
125	11	FL 615 166
160	11	FL 615 168
180	11	FL 615 169
200	11	FL 615 170
225	11	FL 615 171



REPAIR SADDLES

Size (mm)	SDR	Product Code
560	17	FL 616 367
630	17	FL 616 368
710	17	FL 616 369
800	17	FL 616 370
900	17	FL 616 371
1000	17	FL 616 372
1200	17	FL 616 379



TOP LOADING REPAIR SADDLES

Size (mm)	SDR	Product Code
250-560	11	FL 615 397



32MM TOP LOADING TAPPING TEES

Size (mm)	SDR	Product Code
63/2" x 32	11	FL 411 415
75 x 32	11	FL 411 416
90/3" x 32	11	FL 411 417
110-140/4" x 32	11	FL 411 419
160-213/6" x 32	11	FL 411 422
225-315 x 32	11	FL 411 427



UNDER CLAMPED PRESSURE TAPPING TEES

Size (mm)	SDR	Product Code
90 x 63	11	FL 612 701
110 x 63	11	FL 612 624
125 x 63	11	FL 612 309
160 x 63	11	FL 612 650
180 x 63	11	FL 612 652
200 x 63	11	FL 612 659
225 x 63	11	FL 612 655



New product design available*



TOP LOADING PRESSURE TAPPING TEE

Size (mm)	SDR	Product Code
250-315(355-400) x 63	11	FL 615 339



CAP FOR PRESSURE TAPPING TEES

Size (mm)	SDR	Product Code
50	11	FL 612 310



FLANGED BRANCH TEES

Size (mm)	SDR	Product Code
90 x 80 PN16	11	FL 301 313
110 x 80 PN16	11	FL 301 314
125 x 80 PN16	11	FL 301 315
160 x 80 PN16	11	FL 301 317
180 x 80 PN16	11	FL 301 318
90 x 100 PN16	11	FL 302 313
110 x 100 PN16	11	FL 302 314
125 x 100 PN16	11	FL 302 315
160 x 100 PN16	11	FL 302 317
180 x 100 PN16	11	FL 302 318
160 x 150 PN16	11	FL 303 317
180 x 150 PN16	11	FL 303 318

Frialen electrofusion fittings

For potable water applications only



FULL FACED FLANGED BRANCH TEES

Size (mm)	SDR	Product Code
110 x 80 PN16	11	FL 615 590
125 x 80 PN16	11	FL 615 591
160 x 80 PN16	11	FL 615 592
180 x 80 PN16	11	FL 615 910



TRANSITION COUPLERS PE100/ BRASS MALE THREAD

Size (mm x inch)	SDR	Product Code
32 x 1	11	FL 612 712
32 x 1¼	11	FL 612 709
32 x 1½	11	FL 612 698
40 x 1	11	FL 612 721
40 x 1¼	11	FL 612 713
40 x 1½	11	FL 612 718
40 x 2	11	FL 612 725
50 x 1	11	FL 612 719
50 x 1¼	11	FL 612 716
50 x 1½	11	FL 612 714
50 x 2	11	FL 612 706
63 x 1¼	11	FL 612 722
63 x 1½	11	FL 612 717
63 x 2	11	FL 612 715



90° TRANSITION ELBOWS PE100/ BRASS MALE THREAD

Size (mm x inch)	SDR	Product Code
32 x 1	11	FL 612 120
32 x 1½	11	FL 612 140
40 x 1	11	FL 612 127
40 x 1¼	11	FL 612 122
40 x 1½	11	FL 612 121
50 x 1	11	FL 612 119
50 x 1¼	11	FL 612 123
50 x 1½	11	FL 612 124
63 x 1½	11	FL 612 125
63 x 2	11	FL 612 126



TRANSITION COUPLERS PE100/ GUNMETAL FEMALE THREAD

Size (mm x inch)	SDR	Product Code
32 x 1	11	FL 612 595
40 x 1¼	11	FL 612 596
50 x 1½	11	FL 612 692
63 x 1½	11	FL 612 708
63 x 2	11	FL 612 693



DUCK FOOT BENDS

Size (mm)	SDR	Product Code
63 x 80 PN16	11	FL 384 459
90 x 80 PN16	11	FL 384 313
125 x 80 PN16	11	FL 384 484
180 x 80 PN16	11	FL 384 487



FLANGE ADAPTOR KITS

Size (mm)	SDR	Product Code
63 x 50	11	FL 251 311
90 x 80	17	FL 250 313
125 x 100	17	FL 250 315
90 x 100	17	FL 250 484
160 x 150	17	FL 250 317
180 x 150	17	FL 250 318
250 x 250	17	FL 250 321
250 x 200	17	FL 250 534
315 x 300	17	FL 250 323

Accessory



ELECTROFUSION WIPES

	Product Code
Electrofusion iso-propyl Alcohol Wipes 100% (100 per tub)	53 996 603

Actuated Valves

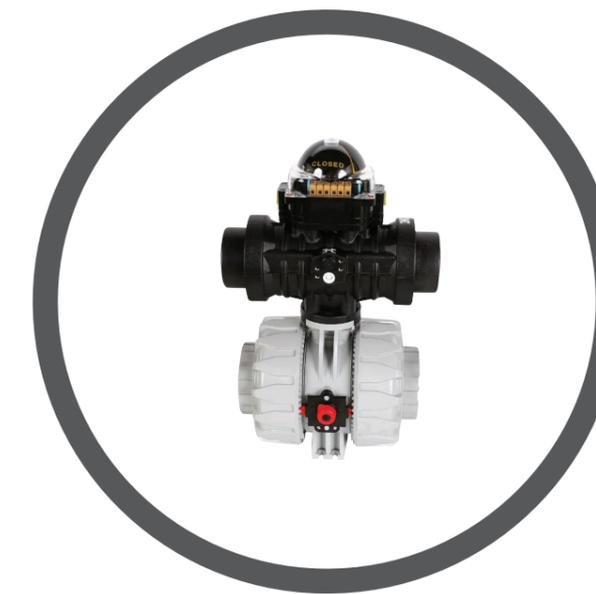

Actuated Valves

Operation: Electric

Our **Speedstock** range can ensure actuated valves are available for dispatch 24 hours after the order is placed and will be sent by courier direct to site. **Speedstock** selected products are highlighted in **red**.



VKD DUAL BLOCK BALL VALVES - Plain Female Ends

Standard Open/Close (100 to 240v) - Imperial

Size	PVC-U		SUPERFLO ABS	
	EPDM	FKM	EPDM	FKM
1/2"	H1 DKE 102	H1 DKF 102	H1 DKA 102	H1 DKB 102
3/4"	H1 DKE 103	H1 DKF 103	H1 DKA 103	H1 DKB 103
1"	H1 DKE 104	H1 DKF 104	H1 DKA 104	H1 DKB 104
1 1/4"	H1 DKE 105	H1 DKF 105	H1 DKA 105	H1 DKB 105
1 1/2"	H1 DKE 106	H1 DKF 106	H1 DKA 106	H1 DKB 106
2"	H1 DKE 107	H1 DKF 107	H1 DKA 107	H1 DKB 107
2 1/2"	H1 DKE 312	H1 DKF 312	H1 DKA 312	H1 DKB 312
3"	H1 DKE 109	H1 DKF 109	H1 DKA 109	H1 DKB 109
4"	H1 DKE 110	H1 DKF 110	H1 DKA 110	H1 DKB 110

Standard Open/Close (24v AC/DC) - Imperial

Size	PVC-U		SUPERFLO ABS	
	EPDM	FKM	EPDM	FKM
1/2"	H2 DKE 102	H2 DKF 102	H2 DKA 102	H2 DKB 102
3/4"	H2 DKE 103	H2 DKF 103	H2 DKA 103	H2 DKB 103
1"	H2 DKE 104	H2 DKF 104	H2 DKA 104	H2 DKB 104
1 1/4"	H2 DKE 105	H2 DKF 105	H2 DKA 105	H2 DKB 105
1 1/2"	H2 DKE 106	H2 DKF 106	H2 DKA 106	H2 DKB 106
2"	H2 DKE 107	H2 DKF 107	H2 DKA 107	H2 DKB 107
2 1/2"	H2 DKE 312	H2 DKF 312	H2 DKA 312	H2 DKB 312
3"	H2 DKE 109	H2 DKF 109	H2 DKA 109	H2 DKB 109
4"	H2 DKE 110	H2 DKF 110	H2 DKA 110	H2 DKB 110

Please contact our Flow Team for further information on our Actuated Valve options: flowteam@alixis.com or call **+44 (0) 1543 471680**

Actuation options available:

- Fail safe closed (battery back up)
- Fail safe open (battery back up)
- 4 -20mA positioning
- PROFIBUS connectivity
- ATEX approved options
- Bluetooth connectivity

Alternative End Connections:

- BSP Female Thread (Excl ABS)
- Flanged PN10/16
- Flanged ANSI 150
- Polyethylene Spigot Ends

Multipoint 3-Way Ball Valve options available

- L- Port / • T- Port

Standard Open/Close (100 to 240v) - Metric

Size	PVC-U		SUPERFLO ABS		CPVC CORZAN		POLYPROPYLENE	
	EPDM	FKM	EPDM	FKM	EPDM	FKM	EPDM	FKM
20mm	H1 DKE 306	H1 DKF 306	H1 DKA 306	H1 DKB 306	H1 DKJ 306	H1 DKK 306	H1 DKN 306	H1 DKP 306
25mm	H1 DKE 307	H1 DKF 307	H1 DKA 307	H1 DKB 307	H1 DKJ 307	H1 DKK 307	H1 DKN 307	H1 DKP 307
32mm	H1 DKE 308	H1 DKF 308	H1 DKA 308	H1 DKB 308	H1 DKJ 308	H1 DKK 308	H1 DKN 308	H1 DKP 308
40mm	H1 DKE 309	H1 DKF 309	H1 DKA 309	H1 DKB 309	H1 DKJ 309	H1 DKK 309	H1 DKN 309	H1 DKP 309
50mm	H1 DKE 310	H1 DKF 310	H1 DKA 310	H1 DKB 310	H1 DKJ 310	H1 DKK 310	H1 DKN 310	H1 DKP 310
63mm	H1 DKE 311	H1 DKF 311	H1 DKA 311	H1 DKB 311	H1 DKJ 311	H1 DKK 311	H1 DKN 311	H1 DKP 311
75mm	H1 DKE 312	H1 DKF 312	H1 DKA 312	H1 DKB 312	H1 DKJ 312	H1 DKK 312	H1 DKN 312	H1 DKP 312
90mm	H1 DKE 313	H1 DKF 313	H1 DKA 313	H1 DKB 313	H1 DKJ 313	H1 DKK 313	H1 DKN 313	H1 DKP 313
110mm	H1 DKE 314	H1 DKF 314	H1 DKA 314	H1 DKB 314	H1 DKJ 314	H1 DKK 314	H1 DKN 314	H1 DKP 314

Standard Open/Close (24v AC/DC) - Metric

Size	PVC-U		SUPERFLO ABS		CPVC CORZAN		POLYPROPYLENE	
	EPDM	FKM	EPDM	FKM	EPDM	FKM	EPDM	FKM
20mm	H2 DKE 306	H2 DKF 306	H2 DKA 306	H2 DKB 306	H2 DKJ 306	H2 DKK 306	H2 DKN 306	H2 DKP 306
25mm	H2 DKE 307	H2 DKF 307	H2 DKA 307	H2 DKB 307	H2 DKJ 307	H2 DKK 307	H2 DKN 307	H2 DKP 307
32mm	H2 DKE 308	H2 DKF 308	H2 DKA 308	H2 DKB 308	H2 DKJ 308	H2 DKK 308	H2 DKN 308	H2 DKP 308
40mm	H2 DKE 309	H2 DKF 309	H2 DKA 309	H2 DKB 309	H2 DKJ 309	H2 DKK 309	H2 DKN 309	H2 DKP 309
50mm	H2 DKE 310	H2 DKF 310	H2 DKA 310	H2 DKB 310	H2 DKJ 310	H2 DKK 310	H2 DKN 310	H2 DKP 310
63mm	H2 DKE 311	H2 DKF 311	H2 DKA 311	H2 DKB 311	H2 DKJ 311	H2 DKK 311	H2 DKN 311	H2 DKP 311
75mm	H2 DKE 312	H2 DKF 312	H2 DKA 312	H2 DKB 312	H2 DKJ 312	H2 DKK 312	H2 DKN 312	H2 DKP 312
90mm	H2 DKE 313	H2 DKF 313	H2 DKA 313	H2 DKB 313	H2 DKJ 313	H2 DKK 313	H2 DKN 313	H2 DKP 313
110mm	H2 DKE 314	H2 DKF 314	H2 DKA 314	H2 DKB 314	H2 DKJ 314	H2 DKK 314	H2 DKN 314	H2 DKP 314

Ask our **Flow Team** about **PROFIBUS** and **Bluetooth** connectivity



Actuated Valves

Operation: Electric



FK BUTTERFLY VALVES - PN10/16 and ANSI 150 Drillings as Standard

Standard Open/Close (100 to 240v)

Size	PVC-U		SUPERFLO ABS		CPVC CORZAN		POLYPROPYLENE	
	EPDM	FKM	EPDM	FKM	EPDM	FKM	EPDM	FKM
1 1/2" - 50mm	H1 FKE 106	H1 FKF 106	H1 FKA 106	H1 FKB 106	H1 FKJ 106	H1 FKK 106	H1 FKN 106	H1 FKP 106
2" - 63mm	H1 FKE 107	H1 FKF 107	H1 FKA 107	H1 FKB 107	H1 FKJ 107	H1 FKK 107	H1 FKN 107	H1 FKP 107
2 1/2" - 75mm	H1 FKE 108	H1 FKF 108	H1 FKA 108	H1 FKB 108	H1 FKJ 108	H1 FKK 108	H1 FKN 108	H1 FKP 108
3" - 90mm	H1 FKE 109	H1 FKF 109	H1 FKA 109	H1 FKB 109	H1 FKJ 109	H1 FKK 109	H1 FKN 109	H1 FKP 109
4" - 110mm	H1 FKE 110	H1 FKF 110	H1 FKA 110	H1 FKB 110	H1 FKJ 110	H1 FKK 110	H1 FKN 110	H1 FKP 110
5" - 140mm	H1 FKE 111	H1 FKF 111	H1 FKA 111	H1 FKB 111	H1 FKJ 111	H1 FKK 111	H1 FKN 111	H1 FKP 111
6" - 160mm	H1 FKE 112	H1 FKF 112	H1 FKA 112	H1 FKB 112	H1 FKJ 112	H1 FKK 112	H1 FKN 112	H1 FKP 112
8" - 225mm	H1 FKE 113	H1 FKF 113	H1 FKA 113	H1 FKB 113	H1 FKJ 113	H1 FKK 113	H1 FKN 113	H1 FKP 113

Standard Open/Close (24v AC/DC)

Size	PVC-U		SUPERFLO ABS		CPVC CORZAN		POLYPROPYLENE	
	EPDM	FKM	EPDM	FKM	EPDM	FKM	EPDM	FKM
1 1/2" - 50mm	H2 FKE 106	H2 FKF 106	H2 FKA 106	H2 FKB 106	H2 FKJ 106	H2 FKK 106	H2 FKN 106	H2 FKP 106
2" - 63mm	H2 FKE 107	H2 FKF 107	H2 FKA 107	H2 FKB 107	H2 FKJ 107	H2 FKK 107	H2 FKN 107	H2 FKP 107
2 1/2" - 75mm	H2 FKE 108	H2 FKF 108	H2 FKA 108	H2 FKB 108	H2 FKJ 108	H2 FKK 108	H2 FKN 108	H2 FKP 108
3" - 90mm	H2 FKE 109	H2 FKF 109	H2 FKA 109	H2 FKB 109	H2 FKJ 109	H2 FKK 109	H2 FKN 109	H2 FKP 109
4" - 110mm	H2 FKE 110	H2 FKF 110	H2 FKA 110	H2 FKB 110	H2 FKJ 110	H2 FKK 110	H2 FKN 110	H2 FKP 110
5" - 140mm	H2 FKE 111	H2 FKF 111	H2 FKA 111	H2 FKB 111	H2 FKJ 111	H2 FKK 111	H2 FKN 111	H2 FKP 111
6" - 160mm	H2 FKE 112	H2 FKF 112	H2 FKA 112	H2 FKB 112	H2 FKJ 112	H2 FKK 112	H2 FKN 112	H2 FKP 112
8" - 225mm	H2 FKE 113	H2 FKF 113	H2 FKA 113	H2 FKB 113	H2 FKJ 113	H2 FKK 113	H2 FKN 113	H2 FKP 113

Please contact our Flow Team for further information on our Actuated Valve options: flowteam@alixis.com or call **+44 (0) 1543 471680**

Actuation options available:

- Fail safe closed (battery back up)
- Fail safe open (battery back up)
- 4 -20mA positioning
- PROFIBUS connectivity
- ATEX approved options
- Bluetooth connectivity

Additional information

- Fully Lugged options (end of line use)
- Larger sizes available upon request (up to 16")
- Alternative drilling's available

Electric Actuator features:

- Integrated anti-condensation heaters
- 2 x Auxiliary adjustable limit switches
- Emergency manual override
- Visual positioning indicator
- IP66 Rated

For **Flow Control** options see **page 130**



Actuated Valves

Operation: Electric



VKR METERING (PRECISION FLOW REGULATING) BALL VALVES – Plain Female Ends

Standard Open/Close (100 to 240v) – Imperial

Size	PVC-U		SUPERFLO ABS	
	EPDM	FKM	EPDM	FKM
½"	H1 MBE 102	H1 MBF 102	H1 MBA 102	H1 MBB 102
¾"	H1 MBE 103	H1 MBF 103	H1 MBA 103	H1 MBB 103
1"	H1 MBE 104	H1 MBF 104	H1 MBA 104	H1 MBB 104
1¼"	H1 MBE 105	H1 MBF 105	H1 MBA 105	H1 MBB 105
1½"	H1 MBE 106	H1 MBF 106	H1 MBA 106	H1 MBB 106
2"	H1 MBE 107	H1 MBF 107	H1 MBA 107	H1 MBB 107

Standard Open/Close (24v AC/DC) – Imperial

Size	PVC-U		SUPERFLO ABS	
	EPDM	FKM	EPDM	FKM
½"	H2 MBE 102	H2 MBF 102	H2 MBA 102	H2 MBB 102
¾"	H2 MBE 103	H2 MBF 103	H2 MBA 103	H2 MBB 103
1"	H2 MBE 104	H2 MBF 104	H2 MBA 104	H2 MBB 104
1¼"	H2 MBE 105	H2 MBF 105	H2 MBA 105	H2 MBB 105
1½"	H2 MBE 106	H2 MBF 106	H2 MBA 106	H2 MBB 106
2"	H2 MBE 107	H2 MBF 107	H2 MBA 107	H2 MBB 107

Please contact our Flow Team for further information on our Actuated Valve options: flowteam@alixis.com or call **+44 (0) 1543 471680**

Actuation options available:

- Fail safe closed (battery back up)
- Fail safe open (battery back up)
- PROFIBUS compatibility
- ATEX approved options

Alternative End Connections:

- BSP Female Threaded (Excl ABS)
- Flanged PN10/16
- Flanged ANSI 150
- Polyethylene Spigot Ends

Electric Actuator features:

- Integrated anti-condensation heaters
- 2 x Auxiliary adjustable limit switches
- Emergency manual override
- Visual positioning indicator
- IP66 Rated

Speak to our **Flow Team** about our **Variable Area Flowmeters**



Actuated Valves

Operation: Pneumatic (Compressed Air)



VKD DUAL BLOCK BALL VALVES – Plain Socket Ends

Fail Safe Closed (FSC) – Imperial

Size	PVC-U		SUPERFLO ABS	
	EPDM	FKM	EPDM	FKM
½"	HP DKE 102	HP DKF 102	HP DKA 102	HP DKB 102
¾"	HP DKE 103	HP DKF 103	HP DKA 103	HP DKB 103
1"	HP DKE 104	HP DKF 104	HP DKA 104	HP DKB 104
1¼"	HP DKE 105	HP DKF 105	HP DKA 105	HP DKB 105
1½"	HP DKE 106	HP DKF 106	HP DKA 106	HP DKB 106
2"	HP DKE 107	HP DKF 107	HP DKA 107	HP DKB 107
2½"	HP DKE 312	HP DKF 312	HP DKA 312	HP DKB 312
3"	HP DKE 109	HP DKF 109	HP DKA 109	HP DKB 109
4"	HP DKE 110	HP DKF 110	HP DKA 110	HP DKB 110

Fail Safe Open (FSO) – Imperial

Size	PVC-U		SUPERFLO ABS	
	EPDM	FKM	EPDM	FKM
½"	HQ DKE 102	HQ DKF 102	HQ DKA 102	HQ DKB 102
¾"	HQ DKE 103	HQ DKF 103	HQ DKA 103	HQ DKB 103
1"	HQ DKE 104	HQ DKF 104	HQ DKA 104	HQ DKB 104
1¼"	HQ DKE 105	HQ DKF 105	HQ DKA 105	HQ DKB 105
1½"	HQ DKE 106	HQ DKF 106	HQ DKA 106	HQ DKB 106
2"	HQ DKE 107	HQ DKF 107	HQ DKA 107	HQ DKB 107
2½"	HQ DKE 312	HQ DKF 312	HQ DKA 312	HQ DKB 312
3"	HQ DKE 109	HQ DKF 109	HQ DKA 109	HQ DKB 109
4"	HQ DKE 110	HQ DKF 110	HQ DKA 110	HQ DKB 110

Please contact our Flow Team for further information on our Actuated Valve options: flowteam@alixis.com or call **+44 (0) 1543 471680**

Accessories:

- Switchbox
- Positioning Indicator
- Solenoid Valves

Actuation options available:

- Double Acting (DA)

Alternative End Connections:

- BSP Female Thread (Excl ABS)
- Flanged PN10/16
- Flanged ANSI 150
- Polyethylene Spigot Ends

Multiport 3-Way Ball Valve options available

- L- Port / • T- Port

Fail Safe Closed (FSC) – Metric

Size	PVC-U		SUPERFLO ABS		CPVC CORZAN		POLYPROPYLENE	
	EPDM	FKM	EPDM	FKM	EPDM	FKM	EPDM	FKM
20mm	HP DKE 306	HP DKF 306	HP DKA 306	HP DKB 306	HP DKJ 306	HP DKK 306	HP DKN 306	HP DKP 306
25mm	HP DKE 307	HP DKF 307	HP DKA 307	HP DKB 307	HP DKJ 307	HP DKK 307	HP DKN 307	HP DKP 307
32mm	HP DKE 308	HP DKF 308	HP DKA 308	HP DKB 308	HP DKJ 308	HP DKK 308	HP DKN 308	HP DKP 308
40mm	HP DKE 309	HP DKF 309	HP DKA 309	HP DKB 309	HP DKJ 309	HP DKK 309	HP DKN 309	HP DKP 309
50mm	HP DKE 310	HP DKF 310	HP DKA 310	HP DKB 310	HP DKJ 310	HP DKK 310	HP DKN 310	HP DKP 310
63mm	HP DKE 311	HP DKF 311	HP DKA 311	HP DKB 311	HP DKJ 311	HP DKK 311	HP DKN 311	HP DKP 311
75mm	HP DKE 312	HP DKF 312	HP DKA 312	HP DKB 312	HP DKJ 312	HP DKK 312	HP DKN 312	HP DKP 312
90mm	HP DKE 313	HP DKF 313	HP DKA 313	HP DKB 313	HP DKJ 313	HP DKK 313	HP DKN 313	HP DKP 313
110mm	HP DKE 314	HP DKF 314	HP DKA 314	HP DKB 314	HP DKJ 314	HP DKK 314	HP DKN 314	HP DKP 314

Fail Safe Open (FSO) – Metric

Size	PVC-U		SUPERFLO ABS		CPVC CORZAN		POLYPROPYLENE	
	EPDM	FKM	EPDM	FKM	EPDM	FKM	EPDM	FKM
20mm	HQ DKE 306	HQ DKF 306	HQ DKA 306	HQ DKB 306	HQ DKJ 306	HQ DKK 306	HQ DKN 306	HQ DKP 306
25mm	HQ DKE 307	HQ DKF 307	HQ DKA 307	HQ DKB 307	HQ DKJ 307	HQ DKK 307	HQ DKN 307	HQ DKP 307
32mm	HQ DKE 308	HQ DKF 308	HQ DKA 308	HQ DKB 308	HQ DKJ 308	HQ DKK 308	HQ DKN 308	HQ DKP 308
40mm	HQ DKE 309	HQ DKF 309	HQ DKA 309	HQ DKB 309	HQ DKJ 309	HQ DKK 309	HQ DKN 309	HQ DKP 309
50mm	HQ DKE 310	HQ DKF 310	HQ DKA 310	HQ DKB 310	HQ DKJ 310	HQ DKK 310	HQ DKN 310	HQ DKP 310
63mm	HQ DKE 311	HQ DKF 311	HQ DKA 311	HQ DKB 311	HQ DKJ 311	HQ DKK 311	HQ DKN 311	HQ DKP 311
75mm	HQ DKE 312	HQ DKF 312	HQ DKA 312	HQ DKB 312	HQ DKJ 312	HQ DKK 312	HQ DKN 312	HQ DKP 312
90mm	HQ DKE 313	HQ DKF 313	HQ DKA 313	HQ DKB 313	HQ DKJ 313	HQ DKK 313	HQ DKN 313	HQ DKP 313
110mm	HQ DKE 314	HQ DKF 314	HQ DKA 314	HQ DKB 314	HQ DKJ 314	HQ DKK 314	HQ DKN 314	HQ DKP 314

Contact our **Flow Team** to find out about our **Double Acting** options



Actuated Valves

Operation: Pneumatic (Compressed Air)



FK BUTTERFLY VALVES - PN 10/16 and ANSI 150 Drilling Options as Standard

Fail Safe Closed (FSC)

Size	PVC-U		SUPERFLO ABS		CPVC CORZAN		POLYPROPYLENE	
	EPDM	FKM	EPDM	FKM	EPDM	FKM	EPDM	FKM
1 1/2" - 50mm	HP FKE 106	HP FKF 106	HP FKA 106	HP FKB 106	HP FKJ 106	HP FKK 106	HP FKN 106	HP FKP 106
2" - 63mm	HP FKE 107	HP FKF 107	HP FKA 107	HP FKB 107	HP FKJ 107	HP FKK 107	HP FKN 107	HP FKP 107
2 1/2" - 75mm	HP FKE 108	HP FKF 108	HP FKA 108	HP FKB 108	HP FKJ 108	HP FKK 108	HP FKN 108	HP FKP 108
3" - 90mm	HP FKE 109	HP FKF 109	HP FKA 109	HP FKB 109	HP FKJ 109	HP FKK 109	HP FKN 109	HP FKP 109
4" - 110mm	HP FKE 110	HP FKF 110	HP FKA 110	HP FKB 110	HP FKJ 110	HP FKK 110	HP FKN 110	HP FKP 110
5" - 140mm	HP FKE 111	HP FKF 111	HP FKA 111	HP FKB 111	HP FKJ 111	HP FKK 111	HP FKN 111	HP FKP 111
6" - 160mm	HP FKE 112	HP FKF 112	HP FKA 112	HP FKB 112	HP FKJ 112	HP FKK 112	HP FKN 112	HP FKP 112
8" - 225mm	HP FKE 113	HP FKF 113	HP FKA 113	HP FKB 113	HP FKJ 113	HP FKK 113	HP FKN 113	HP FKP 113

Fail Safe Open (FSO)

Size	PVC-U		SUPERFLO ABS		CPVC CORZAN		POLYPROPYLENE	
	EPDM	FKM	EPDM	FKM	EPDM	FKM	EPDM	FKM
1 1/2" - 50mm	HQ FKE 106	HQ FKF 106	HQ FKA 106	HQ FKB 106	HQ FKJ 106	HQ FKK 106	HQ FKN 106	HQ FKP 106
2" - 63mm	HQ FKE 107	HQ FKF 107	HQ FKA 107	HQ FKB 107	HQ FKJ 107	HQ FKK 107	HQ FKN 107	HQ FKP 107
2 1/2" - 75mm	HQ FKE 108	HQ FKF 108	HQ FKA 108	HQ FKB 108	HQ FKJ 108	HQ FKK 108	HQ FKN 108	HQ FKP 108
3" - 90mm	HQ FKE 109	HQ FKF 109	HQ FKA 109	HQ FKB 109	HQ FKJ 109	HQ FKK 109	HQ FKN 109	HQ FKP 109
4" - 110mm	HQ FKE 110	HQ FKF 110	HQ FKA 110	HQ FKB 110	HQ FKJ 110	HQ FKK 110	HQ FKN 110	HQ FKP 110
5" - 140mm	HQ FKE 111	HQ FKF 111	HQ FKA 111	HQ FKB 111	HQ FKJ 111	HQ FKK 111	HQ FKN 111	HQ FKP 111
6" - 160mm	HQ FKE 112	HQ FKF 112	HQ FKA 112	HQ FKB 112	HQ FKJ 112	HQ FKK 112	HQ FKN 112	HQ FKP 112
8" - 225mm	HQ FKE 113	HQ FKF 113	HQ FKA 113	HQ FKB 113	HQ FKJ 113	HQ FKK 113	HQ FKN 113	HQ FKP 113

Please contact our Flow Team for further information on our Actuated Valve options: flowteam@alixis.com or call **+44 (0) 1543 471680**

Accessories:

- Switchbox
- Positioning Indicator
- Solenoid Valves

Actuation options available:

- Double Acting (DA)

Additional information:

- Larger sizes available upon request (up to 16")
- Fully lugged options (end of line use)
- Alternative drilling's available

Pneumatic Actuator features:

- Robust polyamide actuator body
- Corrosion resistant
- Visual positioning indicator
- NAMUR/VDI universal mountings

Ask our **Flow Team** about our **Switchbox** and **Solenoid** options



Actuated Valves

Operation: Pneumatic (Compressed Air)



DIALOCK DIAPHRAGM VALVES - Plain Socket Ends

Fail Safe Closed (FSC) - Imperial

Size	PVC-U		SUPERFLO ABS	
	EPDM	FKM	EPDM	FKM
1/2"	HP DVE 102	HP DVF 102	HP DVA 102	HP DVB 102
3/4"	HP DVE 103	HP DVF 103	HP DVA 103	HP DVB 103
1"	HP DVE 104	HP DVF 104	HP DVA 104	HP DVB 104
1 1/4"	HP DVE 105	HP DVF 105	HP DVA 105	HP DVB 105
1 1/2"	HP DVE 106	HP DVF 106	HP DVA 106	HP DVB 106
2"	HP DVE 107	HP DVF 107	HP DVA 107	HP DVB 107
2 1/2"	HP DVE 312	HP DVF 312	HP DVA 312	HP DVB 312
3"	HP VME 209	HP VMF 209	-	-
4"	HP VME 210	HP VMF 210	-	-

Fail Safe Open (FSO) - Imperial

Size	PVC-U		SUPERFLO ABS	
	EPDM	FKM	EPDM	FKM
1/2"	HQ DVE 102	HQ DVF 102	HQ DVA 102	HQ DVB 102
3/4"	HQ DVE 103	HQ DVF 103	HQ DVA 103	HQ DVB 103
1"	HQ DVE 104	HQ DVF 104	HQ DVA 104	HQ DVB 104
1 1/4"	HQ DVE 105	HQ DVF 105	HQ DVA 105	HQ DVB 105
1 1/2"	HQ DVE 106	HQ DVF 106	HQ DVA 106	HQ DVB 106
2"	HQ DVE 107	HQ DVF 107	HQ DVA 107	HQ DVB 107
2 1/2"	HQ DVE 312	HQ DVF 312	HQ DVA 312	HQ DVB 312
3"	HQ VME 209	HQ VMF 209	-	-
4"	HQ VME 210	HQ VMF 210	-	-

Please contact our Flow Team for further information on our Actuated Valve options: flowteam@alixis.com or call **+44 (0) 1543 471680**

Accessories:

- Switchbox
- Positioning Indicator
- Solenoid Valves

Actuation options available:

- Double Acting (DA)
- 4-20mA Positioning Indicator

Alternative End Connections:

- BSP Female Threaded Ends (Excl ABS)
- Flanged PN10/16
- Flanged ANSI 150
- Polyethylene Spigot Ends

Fail Safe Closed (FSC) - Metric

Size	PVC-U		SUPERFLO ABS		CPVC CORZAN		POLYPROPYLENE	
	EPDM	FKM	EPDM	FKM	EPDM	FKM	EPDM	FKM
20mm	HP DVE 306	HP DVF 306	HP DVA 306	HP DVB 306	HP DVJ 306	HP DVK 306	HP DVN 306	HP DVP 306
25mm	HP DVE 307	HP DVF 307	HP DVA 307	HP DVB 307	HP DVJ 307	HP DVK 307	HP DVN 307	HP DVP 307
32mm	HP DVE 308	HP DVF 308	HP DVA 308	HP DVB 308	HP DVJ 308	HP DVK 308	HP DVN 308	HP DVP 308
40mm	HP DVE 309	HP DVF 309	HP DVA 309	HP DVB 309	HP DVJ 309	HP DVK 309	HP DVN 309	HP DVP 309
50mm	HP DVE 310	HP DVF 310	HP DVA 310	HP DVB 310	HP DVJ 310	HP DVK 310	HP DVN 310	HP DVP 310
63mm	HP DVE 311	HP DVF 311	HP DVA 311	HP DVB 311	HP DVJ 311	HP DVK 311	HP DVN 311	HP DVP 311
75mm	HP DVE 312	HP DVF 312	HP DVA 312	HP DVB 312	HP DVJ 312	HP DVK 312	HP DVN 312	HP DVP 312
90mm	HP VME 413	HP VMF 413	-	-	HP VMJ 413	HP VMK 413	HP VMN 413	HP VMP 413
110mm	HP VME 414	HP VMF 414	-	-	HP VMJ 414	HP VMK 414	HP VMN 414	HP VMP 414

Fail Safe Open (FSO) - Metric

Size	PVC-U		SUPERFLO ABS		CPVC CORZAN		POLYPROPYLENE	
	EPDM	FKM	EPDM	FKM	EPDM	FKM	EPDM	FKM
20mm	HQ DVE 306	HQ DVF 306	HQ DVA 306	HQ DVB 306	HQ DVJ 306	HQ DVK 306	HQ DVN 306	HQ DVP 306
25mm	HQ DVE 307	HQ DVF 307	HQ DVA 307	HQ DVB 307	HQ DVJ 307	HQ DVK 307	HQ DVN 307	HQ DVP 307
32mm	HQ DVE 308	HQ DVF 308	HQ DVA 308	HQ DVB 308	HQ DVJ 308	HQ DVK 308	HQ DVN 308	HQ DVP 308
40mm	HQ DVE 309	HQ DVF 309	HQ DVA 309	HQ DVB 309	HQ DVJ 309	HQ DVK 309	HQ DVN 309	HQ DVP 309
50mm	HQ DVE 310	HQ DVF 310	HQ DVA 310	HQ DVB 310	HQ DVJ 310	HQ DVK 310	HQ DVN 310	HQ DVP 310
63mm	HQ DVE 311	HQ DVF 311	HQ DVA 311	HQ DVB 311	HQ DVJ 311	HQ DVK 311	HQ DVN 311	HQ DVP 311
75mm	HQ DVE 312	HQ DVF 312	HQ DVA 312	HQ DVB 312	HQ DVJ 312	HQ DVK 312	HQ DVN 312	HQ DVP 312
90mm	HQ VME 413	HQ VMF 413	-	-	HQ VMJ 313	HQ VMK 413	HQ VMN 413	HQ VMP 413
110mm	HQ VME 414	HQ VMF 414	-	-	HQ VMJ 314	HQ VMK 414	HQ VMN 414	HQ VMP 414

If you'd like to find out more about our **PTFE Diaphragm** options please get in touch



Flow Control Instrumentation

Variable Area Flowmeter:

- Tube materials: PVC-U, Trogamid and Polysulfon
- Range of metering scales available
- Float options: PP, Stainless Steel and Magnetic options
- Flow Switches available
- Socket Union End Connections (Plain or Female BSP)
- EPDM, or FKM seal options



Flow measurement and control:

- Paddlewheel Flow Sensor
- PH/ORP Sensors
- Flow Switches
- Conductivity Sensors
- Magmeters
- Flow Switches
- Pressure/Level Sensor
- Wireless connectivity



Monitors:

- Wall, Panel and Field Mount options
- Integrated Configuration Guide
- LCD display
- SSR outputs
- Mechanical relay outputs
- Current output 4 to 20mA



Wireless Connectivity

Ask our **Flow Team** about our wireless Flow Sensor and connectivity options.



Flow Team

Our dedicated Flow Team can offer technical advice and assemble complex valve packages.

The team has vast experience in offering consultancy on product specifications, undertaking training with

distributors and conducting site visits, with a view to understanding a user's process and application.

Contact our Flow Team on: +44 (0) 1543 471680 or email flowteam@alixis.com

we make life flow



Aliaxis UK reserves the right to modify the details in this publication as products and specifications are updated and improved.

The content of this publication is for general information only and it is user's responsibility to determine the suitability of any product for the purpose intended.

Aliaxis UK Limited, registered in England 01698059. Registered office: Dickley Lane, Lenham, Maidstone, Kent, ME17 2DE

alixis.co.uk

Distributor:

Version: V22023

